



# CONCRETE SIKA CONCRETE HANDBOOK

# Sika Concrete Handbook

---

Editor  
Sika Services AG  
Tueffenwies 16  
CH-8048 Zurich

Authors  
Dipl.-Ing. HTL Jürg Schlumpf, Sika Services AG  
Dipl.-Ing. Bastian Bicher, Sika Services AG  
Dipl.-Ing. Oliver Schwoon, Sika Services AG

Layout  
Sika Services AG  
Corporate Marketing Service

© 2020 by Sika AG  
All rights reserved

Edition 2020

# FOREWORD

This new Concrete Handbook is a chapter by chapter guide about the main methods and processes for the production of concrete to meet different requirements. Of course the growing demands for sustainability in concrete are also taken into consideration.

One of the main requirements for durable concrete is its impermeability. But waterproof concrete alone is not all that is required to make a structure waterproof. A specific chapter 'White Box' on 'Watertight Concrete Construction' which considers the form and dimensions of the design, the waterproof concrete mix design and the alternative solutions for watertight joint sealing has been added to this Concrete Handbook.

Modern concrete is produced from six components. This results in a complex matrix, control of which presents a constantly recurring challenge for everyone involved. For every structure the concrete components must be adapted to both the fresh and the hardened concrete performance requirements.

The authors of the Concrete Handbook have worked in Sika for many years as Engineers in project and product management. This booklet is written both as an introduction to concrete and its application and for a deeper study of the most important building material concrete; it is intended as a reliable source of information for our partners.



# Content

---

<b>FOREWORD</b>	<b>3</b>
<b>1 CONSTRUCTION MATERIAL CONCRETE</b>	<b>7</b>
1.1 Introduction	7
1.2 Basics	8
1.2.1 Concrete terms	8
1.2.2 Admixtures	8
1.3 History of admixtures in Sika	9
1.4 Main uses of concrete	10
<b>2 SUSTAINABILITY</b>	<b>14</b>
2.1 Concrete admixtures and the environment	14
2.2 Powerful and sustainable	16
2.3 Life cycle assessment for concrete admixture	20
<b>3 THE SIX CONCRETE COMPONENTS</b>	<b>24</b>
3.1 Cement and Binder	24
3.1.1 Cement according to European Standard	25
3.1.2 Cement according to ASTM Standard	27
3.2 Concrete aggregates	28
3.2.1 Standard aggregates according to European Standard	29
3.2.2 Aggregates according to ASTM Standard	30
3.2.3 Deleterious sands	31
3.3 Concrete admixtures	36
3.3.1 Concrete admixtures according to European Standard	36
3.3.2 Concrete admixtures according to ASTM Standard	39
3.3.3 Polycarboxylate Ether Technology	40
3.3.4 Sika products	43
3.4 Concrete additions and Supplementary Cementitious Materials (SCM)	44
3.4.1 SCM according to European Standard	44
3.4.2 SCM according to ASTM Standard	45
3.5 Fibers	46
3.5.1 Classification of fibers	47
3.5.2 How to specify fiber-reinforced concrete	48
3.5.3 SikaFiber® range	49
3.6 Water	50
3.6.1 Water according to European Standard	50
3.6.2 Water according to ASTM Standard	51

<b>4</b>	<b>CONCRETE MIX DESIGN</b>	<b>52</b>
4.1	Concrete mix design calculation	52
4.2	Design concept paste volume	56
4.3	Sika mix design tool	60
<b>5</b>	<b>FRESH CONCRETE PROPERTIES AND TESTS</b>	<b>64</b>
5.1	Water / cement – ratio	64
5.1.1	Pan testing method	65
5.1.2	Microwave testing method	65
5.2	Workability and consistence	67
5.3	Hot weather concrete	76
5.4	Cold weather concrete	81
5.5	Fresh concrete air content	84
5.6	Fresh concrete density	85
5.7	Fresh concrete temperature	86
5.8	Cohesion and bleeding	87
<b>6</b>	<b>CONCRETE APPLICATION</b>	<b>90</b>
6.1	Crane and bucket concrete	90
6.2	Pumped concrete	92
6.3	Self-Compacting Concrete (SCC)	96
6.4	Concrete for traffic areas	100
6.5	Mass concrete	102
6.6	Monolithic concrete for industrial floors	104
6.7	Roller-Compacted Concrete (RCC)	106
6.8	Slipform concrete	108
6.9	Sprayed concrete	110
6.10	Wet precast concrete	114
6.11	Tunnel segment concrete	118
6.12	Semi-dry concrete	120
6.13	3D Concrete printing	126
<b>7</b>	<b>HARDENED CONCRETE PROPERTIES AND TESTS</b>	<b>130</b>
7.1	Requirements for specimens and molds	130
7.2	Density	134
7.3	Compressive strength	135
7.4	Flexural strength	141
7.5	Tensile strength	143
7.6	Young's modulus of elasticity (E-Modulus)	144
7.7	Shrinkage	146
7.8	Watertightness	148
7.9	Frost and freeze / thaw resistance	152
7.10	Abrasion resistance	154
7.11	Chemical resistance	156
7.12	Sulfate resistance	158
7.13	AAR resistance	160
7.14	Fire resistance	162
7.15	Chloride migration	164

<b>8</b>	<b>CONCRETE TYPES</b>	<b>166</b>
8.1	Waterproof concrete	166
8.2	Corrosion resistant concrete	170
8.3	Frost and freeze/thaw resistant concrete	174
8.4	Sulfate resistant concrete	178
8.5	Fire resistant concrete	182
8.6	Alkali-silica-reaction resistant concrete	186
8.7	Abrasion resistant concrete	190
8.8	Chemical resistant concrete	194
8.9	High strength concrete	196
8.10	Shrinkage controlled concrete	200
8.11	Fiber reinforced concrete	202
8.12	Fair-faced concrete	206
8.13	Colored concrete	208
8.14	Underwater concrete	210
8.15	Lightweight concrete	212
8.16	Heavyweight concrete	214
8.17	Spun pile concrete	216
8.18	Pervious concrete	218
<b>9</b>	<b>WHITE BOX CONCEPT</b>	<b>222</b>
<b>10</b>	<b>CONSTRUCTION SITE RECOMMENDATIONS</b>	<b>228</b>
10.1	Formwork preparation	228
10.2	Concrete installation	236
10.3	Curing	238
<b>11</b>	<b>STANDARDS</b>	<b>244</b>
11.1	Standards EN 206	244
11.1.1	Definitions from the standard	245
11.1.2	Exposure classes related to environmental actions	246
11.1.3	Classification by consistence	251
11.1.4	Compressive strength classes	252
11.1.5	The k-value (extract from EN 206)	254
11.1.6	Chloride content (extract from EN 206)	256
11.1.7	Specification of concrete	256
11.1.8	Conformity control	257
11.1.9	Proof of other concrete properties	257
11.2	Standards EN 934-2	258
11.2.1	Specific requirements from the standard	258
11.3	ASTM “concrete and aggregates”	266
11.4	ASTM for admixtures	270
<b>12</b>	<b>INDEX</b>	<b>274</b>

# 1 CONSTRUCTION MATERIAL CONCRETE

## 1.1 INTRODUCTION



### **Sika - with Long Experience**

Founded by Kaspar Winkler in 1910, the name Sika today stands for waterproof and durable solutions. Beginning with rendering mortar, used for the first time in the waterproofing of the old Gotthard Railway Tunnel, and extending to entire waterproofing systems for a wide number of applications, which also currently includes the Gotthard Base Tunnel, the longest high-speed railway tunnel in the world, Sika products contribute to building success.

Designing an entire watertight building from basement to roof requires the development of solutions for the widest range of applications, solutions which can be installed practically and provide permanent protection. For a complete structure this means the sealing of surfaces such as roofs, underground walls or foundation plates. It also means assuring the watertightness of construction joints and of movement joints. Furthermore, waterproofing solutions in visible areas must meet high aesthetical requirements.

Alongside water, building structures are exposed to a broad range of forces and strains, starting with mechanical stresses resulting from the type of construction and extending to various external attacks. Extreme hot or cold temperature conditions, aggressive water or other chemicals, continually rolling, abrading or pulsating strains on surfaces, or in extreme cases the impact of fire, places enormous stresses on structures as a whole and on building materials.

Concrete has shaped Sika's development sustainably, and since 1910 Sika has made a notable contribution to the development of concrete as a durable building material!

## 1.2 BASICS

Three main constituents are actually enough to produce concrete:

- Binder (Cement)
- Aggregates
- Water

Due to continually increasing demands for the concrete quality (mainly durability) and huge progress in admixture and concrete technology, it is now possible to produce many different kinds of concrete.

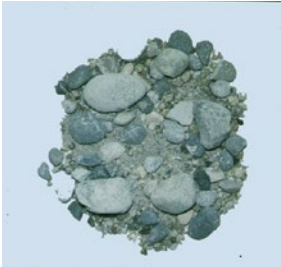

*The aggregates (sand and coarse aggregates) are the main constituents of concrete, at over 70% by volume. The type and quality of the aggregates are therefore vitally important for the properties of the concrete, both fresh and hardened.*

### 1.2.1 CONCRETE TERMS

<b>Standard concrete</b>	Concrete with a maximum particle diameter > 8 mm Density (kiln dried) > 2'000 kg/m <sup>3</sup> and 2'600 kg/m <sup>3</sup>
<b>Heavyweight concrete</b>	Density (kiln dried) > 2'600 kg/m <sup>3</sup>
<b>Lightweight concrete</b>	Density (kiln dried) > 800 kg/m <sup>3</sup> and < 2'000 kg/m <sup>3</sup>
<b>Fresh concrete</b>	Concrete, mixed, while it can still be worked and compacted
<b>Hardened concrete</b>	Concrete when set, with measurable strength
<b>'Green' concrete</b>	Newly placed and compacted, stable, before the start of detectable setting (green concrete is a precasting industry term)

Other terms in use are shotcrete, pumped concrete, craned concrete etc. they define the placement into the formwork, working and/or handling to the point of installation (see Chapter 6).

### 1.2.2 ADMIXTURES

In addition to the three main components of concrete, concrete admixtures and additives are also used in concretes with higher performance specifications again both fresh and hardened.

## 1.3 HISTORY OF ADMIXTURES IN SIKA

Sika began developing the first admixtures for cementitious mixes in 1910, the year in which it was founded. At that time the main aims were to shorten the setting time of mortar mixes, make them waterproof or increase their strength. Some of these early, successful Sika products are still in use today.

Water is necessary in concrete for consistence and hydration of the cement, but too much water is unfavorable for properties of the hardened concrete. Sika products were also developed to reduce the water content while maintaining or even improving the consistence (workability).

Since the company was founded, Sika has always been involved where cement, aggregates, sand and water are mixed into mortar or concrete – Sika your reliable partner for economic construction of durable concrete structures.

Date	Product base	Typical Sika Product	Main effects
1910	Aqueous alkaline solution	<b>Sika®-1</b>	Waterproofing
1930	Lignosulfonate	<b>Plastocrete®</b>	Water reduction up to 10%
1940	Gluconate	<b>Plastiment®</b>	Water reduction up to 10% plus retardation
1960	Mix of carbohydrate and poly-phosphates	<b>Sika® Retarder</b>	Retardation
	Mix of synthetic surfactant	<b>SikaControl® AER</b>	Traditional air-entrainer
1970	Naphthalene	<b>Sikament®</b>	Water reduction up to 20%
1980	Melamine		Water reduction up to 20%
1990	Vinyl copolymers		Water reduction up to 25%
1990	Mixture of organic and inorganic salt solution	<b>SikaRapid®</b>	Hardening acceleration
1992	Amino alcohols	<b>Sika® FerroGard®-901</b>	Corrosion inhibitor
2000	Modified Polycarboxylates (PCE)	<b>Sika® ViscoCrete®</b>	Water reduction up to 40%
2010	Modified Polycarboxylates (PCE)	<b>Sika ViscoFlow®</b>	Slump retention up to 7 hours
2018	Blend of calcium-carbonate and alloy powder	<b>SikaControl® AER-200 P</b>	Chemical air-entrainer

## 1.4 MAIN USES OF CONCRETE



It makes sense to classify the uses of concrete on the basis of where and how it is produced, together with its method of application, since each application has different requirements and properties. The cement sales in 2019 for four different countries are given as an example of how the percentages vary for the different distribution and usage channels for the overall methods of use:

	Cement consumption [%]			
	Germany	USA	China	India
Ready-mix plants	57	67	40	15
Precast component and concrete product producers	22	8	15	15
Contractors	15	13	7	25
Other outlets	6	12	38	45

The right planning and preparation of the concrete works are crucial for the successful use of this building material.

## Preparation steps

When preparing a concrete design, the concrete performance must be defined by the specific project requirements. The following parameters should be considered:

- Strength requirements
- Durability requirements
- Aesthetic requirements
- Maximum aggregate diameter
- Mixing equipment
- Method of placement
- Placing rate
- Concrete consistence (workability time)
- Ambient temperatures
- Curing/surface finishing
- Delivery method & time
- Definition of test requirements
- Mix design and specification
- Preliminary testing
- Mix design adjustment if necessary
- Removal of formwork

## Production



Production of concrete is a critical factor for the resulting concrete and consists basically of dosing and mixing the components. The following parameters can affect the concrete properties during mixing:

- Concrete mix design
- Type, dosage and timing of admixture
- Type and size of mixer
- Mixing intensity and mixing time
- Concrete mixer operator
- Cleaning/maintenance of mixer
- Addition of raw materials
- Plant quality control
- Mixing procedure

## Preparation on site



The preparation on site includes the following:

- Installation of the concrete handling/placing systems
- Preparation of the formwork (including release agent application)
- Reinforcement check
- Formwork check (fixing, integrity, form pressure)
- Supply of tools for compacting (vibrators etc.) and finishing (beams and trowels etc.)



## Delivery



When the concrete is supplied, the following additional criteria must be considered:

- Delivery time (traffic conditions, potential hold-ups, etc.)
- Define the necessary drum revolutions during the journey
- Do not leave the ready-mix truck standing in the sun during waiting periods
- For a fluid consistence, define the maximum capacity to be carried
- Do not add water or extra doses of admixture (unless specified)
- Mix again thoroughly before unloading (one minute per m<sup>3</sup>)

## Placing the concrete



The concrete is generally placed within a limited and defined time period. The following factors contribute to the success of this operation, which is critical for the concrete quality:

- Delivery note check
- Use of the right equipment (vibrators, etc.)
- Avoid over handling the concrete
- Continuous placing and compacting
- Re-compaction on large pours
- Take the appropriate measures during interruptions
- Carry out the necessary finishing (final inspection)

## Curing



To achieve constant and consistent concrete quality, appropriate and correct curing is essential.

The following curing measures contribute to this:

- Generally protect from adverse climatic influences (direct sun, wind, rain, frost, etc.)
- Prevent vibration (after finishing)
- Use a curing agent
- Cover with sheets or frost blankets
- Keep damp/mist or spray if necessary
- Maintain the curing time relevant to the temperature



# 2 SUSTAINABILITY

## 2.1 CONCRETE ADMIXTURES AND THE ENVIRONMENT

Concrete admixtures are liquid or powder additives. They are added to the concrete mix in small quantities to meet specific requirements as to:

- Fix fresh concrete behavior
- Control setting or hardening
- Increase the durability

The intention of admixtures is always to improve the concrete. In quantity terms, superplasticizers (midrange and high range water reducer) and plasticizers (water reducer) as a group represent more than half of all the admixtures used today.

How much do concrete admixtures leach, biodegrade or release volatile substances?

**Admixtures should be non-toxic, water-soluble and biodegradable.**

Tests on pulverized concrete specimens show that small quantities of superplasticizer and their decomposition products are leachable in principle. However, the materials degrade well and do not cause any relevant ground water pollution. Even under the most extreme conditions, only small quantities of organic carbon leaches into the water.

How environment-friendly are superplasticizers?

**Concrete admixtures are appropriate for their application and when correctly used are harmless to humans, animals and the environment.**

The technical benefits of superplasticizer for clients and construction professionals outweigh the occurrence of low, controllable emissions during use. Concrete admixtures merit being rated environmentally-friendly because they create negligible air, soil or ground water pollution.

Publications:

- Association of Swiss Concrete Admixtures Manufacturers (FSHBZ)  
'EFCA-Seal of Environmental Quality for Concrete Admixtures: Technical Guidelines'  
Technical report
- EU Project ANACAD  
'Analysis and Results of Concrete Admixtures in Wastewater'  
Final report BMG

### EFCA Membership

Sika is a member of EFCA, the European Federation of Concrete Admixtures Associations.



Local Sika companies are working around the world together with their local Concrete and Admixtures Associations, to support and promote increasingly sustainable development through the use of concrete admixture technologies.

Selection of associations:



**SACA**  
*Swedish Association for  
Concrete Admixtures*



## 2.2 POWERFUL AND SUSTAINABLE

Concrete admixtures can improve the sustainability of concrete in many different ways. Firstly, they can improve the quality and performance of the concrete significantly, which extends its service life. The addition of stabilizing and special water reducing admixtures also enables recycled aggregates to be used for the production of good quality concrete. Finally, the energy required to obtain high early strengths in precast concrete can be greatly reduced or even completely replaced by water reducing and accelerating admixtures.

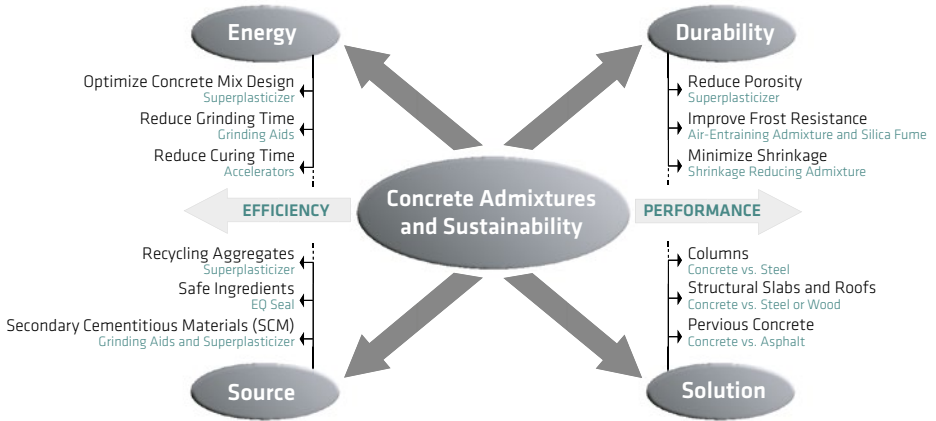

Fig. 2.2.1: Influences of concrete admixtures on sustainability of concrete

### Efficiency

Concrete admixtures are a relevant part to achieve a significant energy reduction of the concreting process. Admixtures have an important task in prospect of sustainability.

### Performance

Concrete is a building material with a remarkable product performance in case of durability and technical solutions and concrete admixtures are part of this successful concept!



## Saving Resources and Reducing Waste in Concrete Production

Concrete is one of the most versatile and durable construction materials known to man, making it the most widely used construction material in the world. It is ubiquitous in our built environment, being used in schools, hospitals, homes, offices, roads, railways, dams etc.. Given the high demand for concrete, its sustainable production and application is an issue of increasing importance for the construction industry and regulators world-wide. Old concrete is being recycled more often. It is crushed and used as aggregates for production of new concrete. Material efficiency is further improved by on-site recycling of excavated material. The environmental benefits are obvious:

- Re-using existing materials reduces extraction of new aggregate materials and
- The pollution caused by transporting waste to landfill sites is reduced

### Admixtures for quality concrete made with recycled aggregates

Recycling preserves natural resources of gravel and sand and reduces demolition waste that otherwise would be disposed in landfills. Recycled aggregates are permitted in a wide range of construction applications and must comply with the requirements of the relevant specification. Sika admixtures allow the use of recycled concrete as an aggregate in concrete production, so that concrete of good quality and workability can be produced.

### Sika Solution: Admixtures for on-site recycling of excavated material

An exemplary implementation of on-site recycling was realized during the construction of the new sport stadium in Zurich. The big challenge was the production of concrete with a constant quality using aggregates produced from material excavated on the construction site. This was only possible with a continuous adjustment of the concrete formulation and Sika's admixture know-how. In addition to saving extraction of raw materials, more than 6'000 truck runs were avoided because fewer transports were necessary.



## Renewable raw materials for Sika® ViscoCrete®

Polycarboxylate ether (PCE) based superplasticizer are nowadays widely used as concrete admixtures to improve concrete workability during placing and durability after hardening. In addition, PCE can be used to reduce the environmental impact of concrete, mainly by enabling concrete mix designs with reduced amounts of cement and / or increased use of secondary cementitious materials such as slag, fly ash or limestone. All high performing PCE superplasticizers are based on monomers derived from crude oil.

All high performing PCE superplasticizers are based on monomers derived from crude oil. As an alternative to crude oil other materials, biobased materials, have been considered. Materials that are derived in whole or in part from biomass resources are biobased. Biomass resources are organic materials that are available on a renewable or recurring basis such as crop residues, wood residues, grasses, and aquatic plants.

Sika has developed a new synthesis technology to produce PCE which are mainly based on renewable raw material. This eco-friendly innovation is in line with one of Sika's stated corporate goals of sustainable product development. Bio-based Sika® ViscoCrete® products were launched end of 2013 in India. Over 80 percent of the oil-based raw materials used in Sika® ViscoCrete® have been replaced by renewable vegetable substances left as waste from sugar production. In addition to the ecological benefits, bio-based Sika® ViscoCrete® also enhances concrete properties, including a substantial water reduction and robust behavior in fresh concrete, creating an ideal balance between its density and its flow characteristics.

Sika France has taken the bio-based PCE and formulated a Sika® ViscoCrete® product. The resulting product named Sika® ViscoCrete®-850 Vegetal has been part of an award winning project donated by the French ready-mix association for the "Sustainable Building E-C- Competition". The winners were selected according to several criteria, including the design of the project, its performance (made possible by concrete), its quality and its economic efficiency, in focus was the ability to reduce the CO<sub>2</sub> footprint.





## 2.3 LIFE CYCLE ASSESSMENT FOR CONCRETE ADMIXTURE

Megatrends are identified which will change also the needs for building materials as concrete. The selected megatrends are:

- Energy and resource efficiency
- Climate change
- Water scarcity
- Rising need for efficient infrastructure
- Rising need for hazard-free and safe products

Life Cycle Assessment (LCA) provides a method to quantify and evaluate potential environmental impacts throughout a product's life cycle from raw material purchase through production, use, end-of-life treatment, recycling to final disposal, commonly called cradle to grave (ISO, 2006). LCA assists evaluating products and activities within the megatrend framework, namely by providing a quantitative assessment of their environmental profile. This enables to improve and differentiate products.

Cradle to Gate approach:

In a "Cradle to Gate" approach, the LCA investigates the potential environmental impact of a product from raw material extraction to finished production.

For concrete admixtures four impact categories and resource indicators below are considered to be the most relevant:

- Cumulative Energy Demand (net calorific value)
- Global Warming Potential (GWP 100 years)
- Eco Indicator 99
- Input of Net Freshwater

Table 2.3.1: Life cycle analysis of an ecologically optimized concrete mix design

Parameter of comparison	Concrete mix design reference	Optimized concrete mix design
Mix design comparison	Cement: 350 kg/m <sup>3</sup> Additive: 0 kg/m <sup>3</sup> Water content (0.52): 182 L/m <sup>3</sup> Sand: 857 kg/m <sup>3</sup> Gravel: 1'007 kg/m <sup>3</sup>	Cement: 280 kg/m <sup>3</sup> Additive: (Limestone) 40 kg/m <sup>3</sup> Water content (0.52): 145.6 L/m <sup>3</sup> Sand: 926 kg/m <sup>3</sup> Gravel: 1'087 kg/m <sup>3</sup> Superplasticizer: 3.36 kg/m <sup>3</sup>
Concrete technology comparison	Fresh concrete: Flow table spread (FTS): 44 cm  Compressive strength: 1-day: 22.3 N/mm <sup>2</sup> 28-day: 40.0 N/mm <sup>2</sup>  Porosity: 4.8%	Fresh concrete: Flow table spread (FTS): 42 cm  Compressive strength: 1-day: 22.4 N/mm <sup>2</sup> 28-day: 41.4 N/mm <sup>2</sup>  Porosity: 2.8%
Economic comparison	€/m <sup>3</sup> 80.75  Additional costs: more cement and water	€/m <sup>3</sup> 80.25  Additional costs: more admixture, limestone, gravel and sand
<b>Life Cycle Impact Assessment</b>		
<b>Cradle-to-gate (Method: CML2001 - Nov.09)</b>		
Input net freshwater	182 L/m <sup>3</sup>	146 L/m <sup>3</sup>
Global warming potential	286 kg CO <sub>2</sub> -Equiv./m <sup>3</sup>	230 kg CO <sub>2</sub> -Equiv./m <sup>3</sup>
Cumulative energy demand	1'196 MJ/m <sup>3</sup>	982 MJ/m <sup>3</sup>
Eco indicator 99	4.5 points	3.7 points

## Example: Ethylene Concrete Buffer Tank

A one million tons ethylene concrete buffer tank was built in Belgium. The total concrete volume is 3'461 m<sup>3</sup>. To show the benefits of using Sika® ViscoCrete® superplasticizer technology in this specific project, a Life Cycle Assessment (LCA) of two concrete systems with the same performance (w/c-ratio of 0.46) was made. The concrete system contains a superplasticizer in its recipe, while the alternative concrete system was designed to provide the same performance without the addition of a superplasticizer. The LCA is from Cradle to Gate, which includes all life cycle stages from raw material extraction and logistics to manufacturing and packaging.

### Results and conclusion

To assess the gains from using the superplasticizer in terms of water and cement reduction, the input of net freshwater use, Cumulative Energy Demand and Global Warming Potential (GWP) for both concrete systems are shown below. The input of net freshwater accounts for the consumption of fresh water (e.g. feed water, ground water, lake water, river water, surface water). The GWP measures the potential contribution to climate change, focusing on emissions of greenhouse gases (e.g. CO<sub>2</sub>, CH<sub>4</sub>), which enhance the heat radiation absorption of the atmosphere, causing the temperature at the earth's surface to rise.



### Input Water [m<sup>3</sup>]

Consumption of water (for the concrete production)

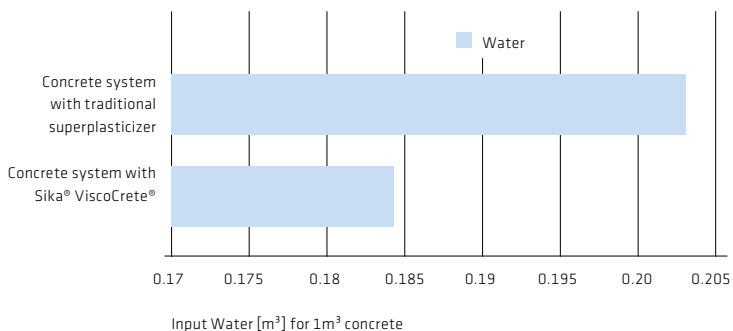

Fig. 2.3.1: Input Net Freshwater with and without Sika® ViscoCrete®



## Global Warming Potential [kg CO<sub>2</sub>-eq.], CML 2001

Potential contribution to climate change due to greenhouse gases emission

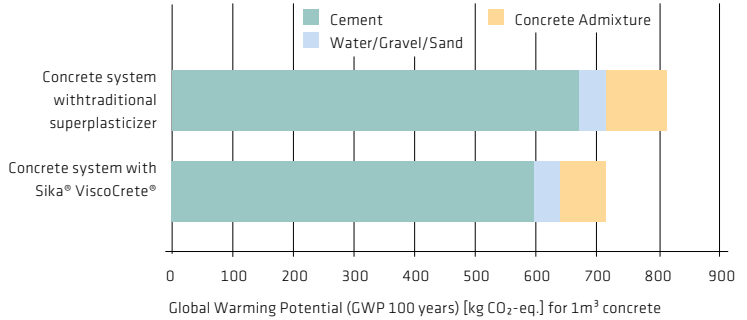

Fig. 2.3.2: Global Warming Potential with and without Sika® ViscoCrete®



## Cumulative Energy Demand [MJ]

Total amount of primary energy from renewable and non-renewable resources

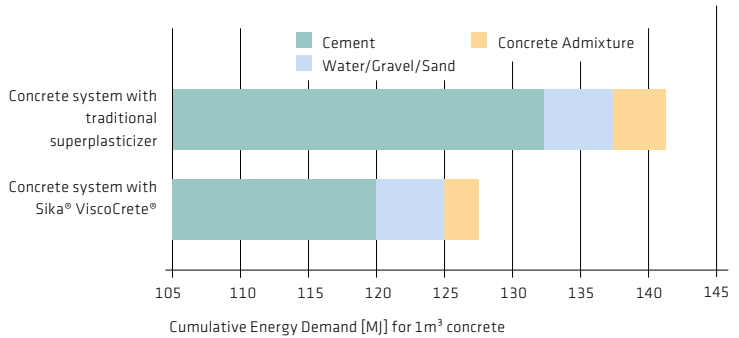
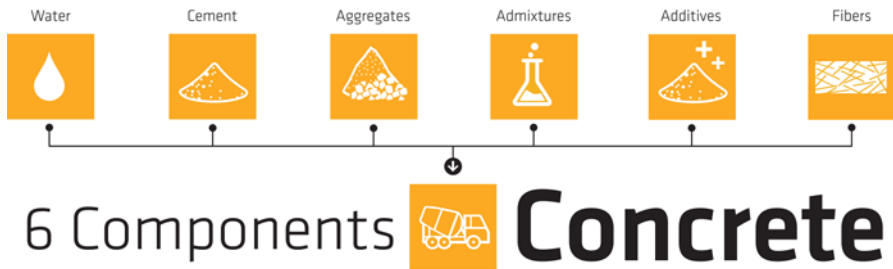

Fig. 2.3.3: Cumulative energy demand with and without Sika® ViscoCrete®

# 3 THE SIX CONCRETE COMPONENTS



Concrete is a versatile building material. In the past concrete has been made of cement, water and aggregates. In order to fulfil the increasing requirements modern concrete is produced from up to six components. This results in a complex matrix, which presents a recurring challenge for all involved. For every structure the concrete components must be adapted to both the fresh and the hardened concrete performance requirements.

## 3.1 CEMENT AND BINDER

Cement is the hydraulic binder (hydraulic = hardening when combined with water) which is used to produce concrete. Cement paste (cement mixed with water) sets and hardens by hydration, both in air and under water. The main base materials, e.g. for Portland cement, are limestone, marl and clay, which are mixed in defined proportions. This raw mix is burned at about 1450 °C to form clinker which is later ground to the well-known fineness of cement.



### 3.1.1 CEMENT ACCORDING TO EUROPEAN STANDARD

In Europe, cements are covered by the standard EN 197-1 (composition, specifications and conformity criteria). The standard divides the common cements into five main types, as follows:

CEM I	Portland cement
CEM II	Composite cements (mainly consisting of Portland cement)
CEM III	Blast furnace cement
CEM IV	Pozzolan cement
CEM V	Composite cement

The various types of cement may contain different components amongst Portland cement clinker (K):

Major components	Type index (EN 197-1)
Granulated slag	S
Silica dust	D
Natural and industrial pozzolans	P or Q
Silica-rich fly ashes	V
Lime-rich fly ashes	W
Burnt shales (e.g. oil shale)	T
Limestone	L or LL

#### Minor components

These are mainly selected inorganic mineral materials originating from clinker production, or components as described (unless they are already contained in the cement as a major constituent, see Page 26).

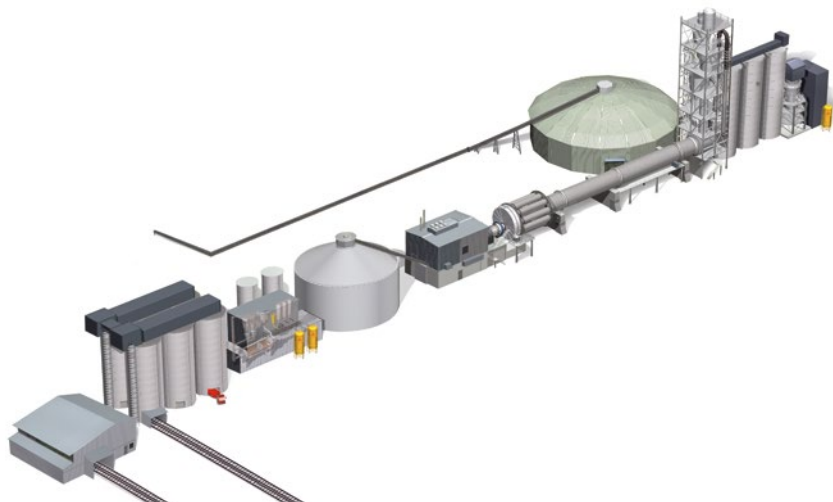

Table 3.1.1: Types of cement and their composition according to EN 197-1

Main cement type	Composition (parts by weight in %) <sup>1</sup>												Minor components	
	Designation	Cement type	Main components											
			Portland cement clinker	Slag	Silica dust	Pozzolanes		Fly ashes		Burnt shale	Limestone			
						Natural	Artificial	High silica	High lime					
K	S	D <sup>2</sup>	P	Q	V	W	T	L <sup>4</sup>	L <sup>5</sup>					
CEM I	Portland cement	CEM I	95-100	-	-	-	-	-	-	-	-	-	-	0-5
CEM II	Portland slag cement	CEM II/A-S	80-94	6-20	-	-	-	-	-	-	-	-	-	0-5
		CEM II/B-S	65-79	21-35	-	-	-	-	-	-	-	-	-	0-5
	Portland silica dust cement	CEM II/A-D	90-94	-	6-10	-	-	-	-	-	-	-	-	0-5
	Portland pozzolan cement	CEM II/A-P	80-94	-	-	6-20	-	-	-	-	-	-	-	0-5
		CEM II/B-P	65-79	-	-	21-35	-	-	-	-	-	-	-	0-5
		CEM II/A-Q	80-94	-	-	-	6-20	-	-	-	-	-	-	0-5
		CEM II/B-Q	65-79	-	-	-	21-35	-	-	-	-	-	-	0-5
	Portland fly ash cement	CEM II/A-V	80-94	-	-	-	-	6-20	-	-	-	-	-	0-5
		CEM II/B-V	65-79	-	-	-	-	21-35	-	-	-	-	-	0-5
		CEM II/A-W	80-94	-	-	-	-	-	6-20	-	-	-	-	0-5
		CEM II/B-W	65-79	-	-	-	-	-	21-35	-	-	-	-	0-5
	Portland shale cement	CEM II/A-T	80-94	-	-	-	-	-	-	6-20	-	-	-	0-5
		CEM II/B-T	65-79	-	-	-	-	-	-	21-35	-	-	-	0-5
	Portland limestone cement	CEM II/A-L	80-94	-	-	-	-	-	-	-	-	6-20	-	0-5
		CEM II/B-L	65-79	-	-	-	-	-	-	-	-	21-35	-	0-5
		CEM II/A-LL	80-94	-	-	-	-	-	-	-	-	-	6-20	0-5
CEM II/B-LL		65-79	-	-	-	-	-	-	-	-	-	21-35	0-5	
Portland composite cement <sup>3</sup>	CEM II/A-M	80-94	6-20									0-5		
	CEM II/B-M	65-79	21-35									0-5		
CEM III	Blast furnace cement	CEM III/A	35-64	36-65	-	-	-	-	-	-	-	-	-	0-5
		CEM III/B	20-34	66-80	-	-	-	-	-	-	-	-	-	0-5
		CEM III/C	5-19	81-95	-	-	-	-	-	-	-	-	-	0-5
CEM IV	Pozzolane cement	CEM IV/A	65-89	-	11-35					-	-	-	0-5	
		CEM IV/B	45-64	-	21-55					-	-	-	0-5	
CEM V	Composite cement <sup>3</sup>	CEM V/A	40-64	18-30	-	18-30			-	-	-	-	0-5	
		CEM V/B	20-39	31-50	-	31-50			-	-	-	-	0-5	

1 The numbers in the table refer to the total major and minor components.

2 The silica dust content is limited to 10%.

3 In the Portland composite cements CEM II/A-M and CEM II/B-M, the pozzolan cements CEM IV/A and CEM IV/B and the composite cements CEM V/A and CEM V/B, the major component type must be specified by the cement designation.

4 Total organic carbon (TOC) must not exceed 0.2% by weight.

5 Total organic carbon (TOC) must not exceed 0.5% by weight.

### 3.1.2 CEMENT ACCORDING TO ASTM STANDARD

According to ASTM regulations cement is described as:

Portland Cement    ASTM C150

Blended Cement    ASTM C595

**ASTM C150 Standard Specification for Portland Cement** covers the following cement types:

<b>Type I</b>	For use when the special properties specified for any other type are not required
<b>Type IA</b>	Air-entraining cement for the same uses as Type I, where air-entrainment is desired
<b>Type II</b>	For general use, more especially when moderate sulfate resistance is desired
<b>Type IIA</b>	Air-entraining cement for the same uses as Type II, where air-entrainment is desired
<b>Type II(MH)</b>	For general use, more especially when moderate heat of hydration and moderate sulfate resistance are desired
<b>Type II(MH)A</b>	Air-entraining cement for the same uses as Type II(MH), where air-entrainment is desired
<b>Type III</b>	For use when high early strength is desired
<b>Type IIIA</b>	Air-entraining cement for the same use as Type III, where air-entrainment is desired
<b>Type IV</b>	For use when a low heat of hydration is desired
<b>Type V</b>	For use when high sulfate resistance is desired

**ASTM C 595 Standard Specification for Blended Hydraulic Cement** covers blended hydraulic cements for both general and special applications, using slag or pozzolan, or both, with Portland cement or Portland cement clinker or slag with lime.

These cements are classified as following:

<b>Type IS</b>	Portland blast-furnace slag cement
<b>Type IP</b>	Portland-pozzolan cement
<b>Type IT</b>	Ternary blended cement

They can also be described according to air-entraining, moderate sulfate resistance, moderate heat of hydration, high sulfate resistance, or low heat of hydration properties.



## 3.2 CONCRETE AGGREGATES

Concrete aggregates, consisting of sand and coarse aggregates, represent the grain skeleton of the concrete. All cavities within this skeleton have to be filled with binder paste as complete as possible. Concrete aggregates sum up to approximately 80% of the concrete weight and 70% of the concrete volume. Optimum use of the aggregate size and quality improves the concrete quality.



Aggregates can occur naturally (fluvial or glacial) or industrially produced like lightweight aggregates or recycled aggregates. For high-quality concrete they are cleaned and graded in industrial facilities by mechanical processes such as crushing, washing, screening and mixing together.

Concrete aggregates should have a strong bond with the hardened cement paste, should not interfere with the cement hardening, and should not have negative effect on concrete durability.

Aggregates	Density	Source
Standard	2.2 – 3.0 kg/dm <sup>3</sup>	From natural deposits, e.g. river gravel, moraine gravel etc. Material round or crushed (e.g. excavated tunnel)
Heavyweight	> 3.0 kg/dm <sup>3</sup>	Such as barytes, iron ore, steel granulate for heavy concrete (e.g. radiation shielding concrete)
Lightweight	< 2.0 kg/dm <sup>3</sup>	Such as expanded clay, pumice, polystyrene for lightweight concrete, insulating concretes
Hard	> 2.5 kg/dm <sup>3</sup>	Such as quartz, carborundum for granolithic concrete surfacing
Recycled granulates	approx. 2.4 kg/dm <sup>3</sup>	From crushed old concrete etc.

### 3.2.1 STANDARD AGGREGATES ACCORDING TO EUROPEAN STANDARD

In Europe aggregates are defined in standard EN 12620. This standard is very comprehensive and to give more details than in the list below would be outside the scope of this document.

**Important terms from the standard** (with additional notes):

■ **Natural aggregate**

Comes from mineral deposits; it only undergoes mechanical preparation and/or washing.

■ **Aggregate mix**

Aggregate consisting of a mixture of coarse and fine aggregates (sand).

An aggregate mix can be produced without prior separation into coarse and fine aggregates or by combining single fractions of coarse and fine aggregates (sand).

■ **Recycled aggregate**

Aggregate made from mechanically processed inorganic material previously used as a building material (i.e. concrete).

■ **Filler (rock flour)**

Aggregate predominantly passing the 0.063 mm sieve, which is added to obtain specific properties.

■ **Particle size group**

Designation of an aggregate by lower (d) and upper (D) sieve size, expressed as d/D.

■ **Fine aggregate (sand)**

Designation for smaller size fractions with D not greater than 4 mm.

Fine aggregates can be produced by natural breakdown of rock or gravel and/or crushing of rock or gravel, or by the processing of industrially produced minerals.

■ **Coarse aggregate**

Name (term) for larger size fractions with D not less than 4 mm and d not less than 2 mm.

■ **Naturally formed aggregate 0/8 mm**

Designation for natural aggregate of glacial or fluvial origin with D not greater than 8 mm (can also be produced by mixing processed aggregates).

■ **Fines**

Proportion of an aggregate passing the 0.063 mm (Recommendation for mix design considerations: 0.125 mm) sieve.

■ **Granulometric composition**

Particle size distribution, expressed as the passing fraction in percent by weight through a defined number of sieves.

### **Passing fraction, particle size distribution curves**

The particle size is expressed by the hole size of the test sieves just passed by the particle concerned.

It is of high importance to design a reasonable combination of the different materials and their corresponding fractions in order to achieve a continuous combined grading curve (see page 41).

### **3.2.2 AGGREGATES ACCORDING TO ASTM STANDARD**

According to ASTM specification three different principal aggregate types are described:

#### *Normal weight:*

Coarse and fine normal weight aggregates      ASTM C33

#### *Lightweight:*

Lightweight aggregates for structural concrete      ASTM C330

Lightweight aggregates for masonry concrete      ASTM C331

Lightweight aggregates for insulating concrete      ASTM C332

#### *Heavyweight:*

Heavyweight aggregates      ASTM C637  
(aggregates for radiation-shielding concrete)

**ASTM C33 Standard Specification for Concrete Aggregates** defines the requirements for grading and quality of fine and coarse aggregate for use in concrete.

Fine aggregate shall consist of natural sand, manufactured sand, or a combination thereof. Fine aggregate shall be free of injurious amounts of organic impurities. Fine aggregate for use in concrete that will be subject to wetting, extended exposure to humid atmosphere, or contact with moist ground shall not contain any materials that are deleteriously reactive with the alkalis in the cement in amount sufficient to cause excessive expansion of mortar or concrete. Fine aggregate subjected to five cycles of the soundness test shall have a required weighted average loss.

Coarse aggregate shall consist of gravel, crushed gravel, crushed stone, air-cooled blast furnace slag, or crushed hydraulic-cement concrete, or a combination thereof.

### **ASTM C330/331/332 Standard Specification for Lightweight Aggregates for Concrete**

covers the requirements of lightweight aggregates intended for use in various types of concrete applications in which prime consideration is reduced density while maintaining the compressive strength of the concrete.

Two general types of lightweight aggregates are covered by this specification:

- Aggregates prepared by expanding, pelletizing, or sintering products such as blast-furnace slag, clay, diatomite, fly ash, shale, or slate; and
- Aggregates prepared by processing natural materials, such as pumice, scoria, or tuff

The aggregates shall be composed predominately of lightweight-cellular and granular inorganic material. Lightweight aggregates shall be tested, and should not contain excessive amounts of deleterious substances; and should conform to the specified values of organic impurities, aggregate staining, aggregate loss of ignition, clay lumps and friable particles, loose bulk density, compressive strength, drying shrinkage, popouts, and resistance to freezing and thawing.

### **ASTM C637 Standard Specification for Aggregates for Radiation-Shielding Concrete**

covers special aggregates for use in radiation-shielding concretes in which composition or high specific gravity, or both, are of prime consideration.

Aggregates covered by this specification include:

- Natural mineral aggregates of either high density or high fixed water content, or both. (These include aggregates that contain or consist predominately of materials such as barite, magnetite, hematite, ilmenite, and serpentine).
- Synthetic aggregates such as iron, steel, ferrophosphorus and boron frit or other boron compounds (see Descriptive Nomenclature C638).
- Fine aggregate consisting of natural or manufactured sand including high-density minerals.
- Coarse aggregate may consist of crushed ore, crushed stone, or synthetic products, or combinations or mixtures thereof.

### 3.2.3 DELETERIOUS SANDS

Aggregates, sand and coarse, are added to concrete as a kind of inert filler also referred to as “rock skeleton”. The specific grading ensures a maximal space filling paired with optimal physical properties, during application and of the final construction element. While the coarser aggregates, apart from shape issues, usually meet this concept, problems often arise from the nature and origin of the smaller fractions. Their fine and finest components respectively impurities cause various concrete technological problems.



The variability of the sands and their impurities results from:

- Mineralogy
- Particle sizes and shapes
- Degradation process from rock to sand (abrasion by glaciers, rivers, sea or wind)
- Degree of mineralogical degradation (dense or layered mineral structure)
- Mechanical processing (crushing, sieving, washing)

Sand suitable for concrete production is increasingly becoming a rare raw material, world-wide. Even if one might think with regard to the deserts of this earth that sand should be infinitely available, this is exactly not the case. Desert sands, in particular, are unsuitable for concrete because of their extremely smooth surface.

Two main problem issues must be considered when sand related problems arise:

#### 1. Effect of particle size

With decreasing diameter of particles their specific surface area (surface area per mass [ $\text{m}^2/\text{g}$ ]) increases directly proportional. For example, the specific outer surface of fine particles in the below 100 micrometer range is about 200 times larger than that of 8 – 10 mm sand grains.

A to high content of fines, thus, does substantially increase the surface inherent of the concrete mix which requires additional water and/or admixtures in order to achieve a reasonable workability as specified. As a result, the water content would become far too high and/or admixtures ineffective. However, even more problematic is the deviation of these fines content which makes a continuously homogenous concrete production difficult.

## 2. Adsorption properties

Also possible, problematic fine components of the aggregates may be clay minerals or mica. These minerals might cause serious issues due to their specific layered crystal structure. Depending on the type of mineral, these layered silicates can not only intercalate smaller molecules and ions but also swell strongly. Thus, the specific surface area increases dramatically again and changes in part over time. In this case even the very large polycarboxylate ether (PCE) are partially or completely removed from the concrete system.

Clay minerals and mica thus result in an individually very different water requirement and the superplasticizers in particular are severely limited in their effectiveness. Specific Sika® ViscoCrete® superplasticizers allow a targeted compensation of such disadvantageous sand properties and in addition Sika® Stabilizer VMC is also available as a special stabilizing admixture for these cases.

## Solving aggregate challenges in concrete production

Sika developed a concept for finding the right solution for the issues observed by the customer related to sands and aggregates. In many cases, the reason for changing or problematic concrete properties is not obvious. Therefore, several steps are required to identify the problem to give the right support and product solutions.

With our concept, we want to help you unlock the safe using the Sika **C.O.D.E.** method.



1. Customer Challenge
2. Operated Analysis
3. Diagnosis of Cause
4. Effective Sika Solution
5. Unlocked Projects

### **C – Customer challenge**

It is important to listen to the customer and understand the challenges that he or she must solve. Sika experts discuss the problems with customers while making sure to fully understand their needs. The following issues may arise in concrete production:

- High water demand
- High admixture absorption
- Stickiness
- Bleeding/ segregation
- Pumpability
- Poor surface quality
- Slump retention

### **D – Diagnosis of the cause**

With the analytical results, the cause of the customer challenge can be diagnosed. Of course, it can be that there are several causes that lead to an issue.

However, most of them can be found in this list:

- Water absorption
- Admixture absorption
- The particles have an unfavorable shape (e.g. too edgy for crushed sands).
- High fines
- Low fines

### **O – Outcome of analysis**

The next step in the Sika C.O.D.E. concept is the analysis. Samples of the sands and aggregates are analysed using several methods in the Sika technology labs all over the world. The focus of the analysis involves the following points:

- Mineralogy
- Grading
- Absorption
- Aspect

### **E – Effective Sika solution**

After the identification of the cause, our Sika experts can work on the most effective solution for our customer. The solution can be a product, combination of products, technical support or both products and support. Amongst others, the following solutions can be offered:

- Concrete mix design app
- Technical Support
- Water reducers
- Stabilizers



## 3.3 CONCRETE ADMIXTURES

Concrete admixtures are liquids or powders which are added to the concrete during mixing in small quantities. The Dosage is usually defined based on the cement content (expressed as % by weight of cement or %bwc).

Concrete admixtures have significant impact on the fresh and/or hardened concrete properties. Admixtures can act chemically and / or physically on the cement hydration.



### 3.3.1 CONCRETE ADMIXTURES ACCORDING TO EUROPEAN STANDARD

According to EN 206, concrete admixtures are defined and the requirements are described in EN 934-2. In the standard EN 934-2 the different product groups are defined, which are described as extracts in the Table 3.3.2 and 3.3.3.

Table 3.3.1: Dosage of admixtures according to EN 206:

<b>Permitted dosage</b>	$\leq 5\%$ by weight of the cement (The effect of a higher dosage on the performance and durability of the concrete must be verified.)
<b>Low dosages</b>	Admixture quantities $< 0.2\%$ of the cement are only allowed if they are dissolved in part of the mixing water.)

If the total quantity of liquid admixture is  $> 3 \text{ L/m}^3$  of concrete, their water quantity must be included in the w/c-ratio calculation.

If more than one admixture is added, their compatibility must be verified by specific testing.

Table 3.3.2: Admixtures – according to EN 934-2:

### Water reducing admixture / Plasticizer

Admixture which permits a reduction in the water content of a given mix without affecting the consistence, or which increases the slump/flow without affecting the water content; or produces both effects simultaneously.

### High range water reducer / Superplasticizer

Admixture which permits a high reduction in the water content of a given mix without affecting the consistence, or which increases the slump/flow considerably without affecting the water content; or produces both effects simultaneously.

### Retarder and Water reducing admixture

Combines effects of a water reducing admixture (primary effect) and a retarder (secondary effect).

### Retarder and Superplasticizer

Combines effects of a superplasticizer (primary effect) and a retarder (secondary effect).

### Set accelerator and Water reducing admixture

Combines effects of a water reducing admixture (primary effect) and a set accelerating admixture (secondary effect).

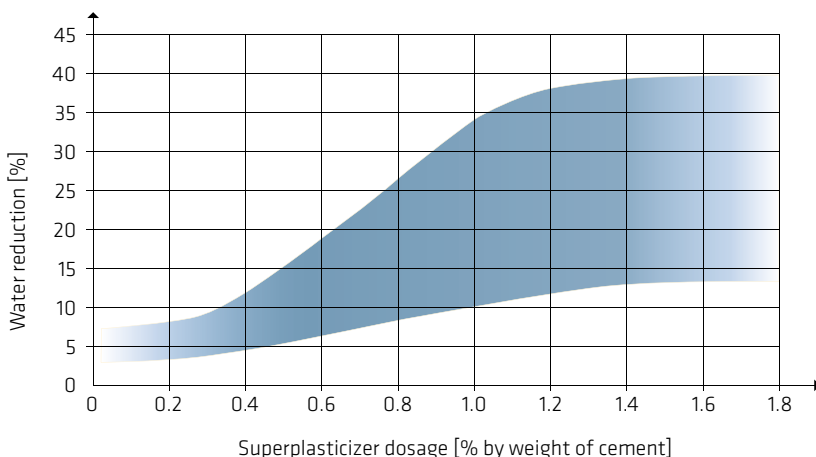

Fig. 3.3.1: Water reduction with Sika® ViscoCrete® / SikaPlast® / Sikament®

Table 3.3.3: Admixtures – according to EN 934-2:

**Viscosity modifying agent (stabilizer/water retaining admixture)**

Reduces the loss of mixing water by reduction of bleeding of the fresh concrete.

**Air-entraining agent**

Provides evenly distributed air voids system by introducing a specific quantity of small air bubbles during the mixing process which remain in the concrete after it hardens.

**Set accelerator**

Reduces the time to initial set, with an increase in initial strength.

**Hardening accelerator**

Accelerates the early strength development of the concrete, without or with minor influence on the setting time and plastic properties of freshly mixed concrete.

**Retarder**

Extends the time to initial set, with an extended workability time and retardation of early strength development.

**Water resisting admixture**

Reduces the capillary water absorption of hardened concrete.

Table 3.3.4: Additional concrete admixtures not defined in European regulations:

**Shrinkage reducing admixtures**

Reduces early age drying shrinkage of the concrete in order to prevent drying shrinkage cracks.

**Pumping aid**

Admixture to improve the stability of the fresh concrete and easy pumping of concrete especially with application of difficult aggregates and unfavourable grading curves.

**Corrosion inhibiting admixtures**

Admixture producing a protective layer on the steel reinforcement in reinforced concrete. As a result start of corrosion is delayed and corrosion speed is decreased leading to extended durability.

**Surface improving admixtures**

Blowhole reducing admixture that significantly reduces the overall air void content in the fresh concrete for production of high quality fair-faced concrete.

**Admixtures to control alkali-silica reaction**

Admixture allowing for control of alkali-silica reaction (ASR) in high-alkali concrete. Application minimizes deleterious expansions in concrete due to ASR and increases durability and life span of the concrete structure.

### 3.3.2 CONCRETE ADMIXTURES ACCORDING TO ASTM STANDARD

According to ASTM regulations concrete admixtures are described as:

Chemical Admixtures	ASTM C494
Air-Entraining Admixtures	ASTM C260
Corrosion Inhibiting Admixtures	ASTM C1582
Pigments	ASTM C979
Cold-Weather Admixture Systems	ASTM C1622
Shotcrete Admixtures	ASTM C1141

**ASTM C494 Standard Specification for Chemical Admixtures for Concrete** covers the materials and the test methods for use in chemical admixtures to be added to hydraulic-cement concrete mixtures in the field.

The standard states the following eight types:

- Type A Water-reducing admixtures
- Type B Retarding admixtures
- Type C Accelerating admixtures
- Type D Water-reducing and retarding admixtures
- Type E Water-reducing and accelerating admixtures
- Type F Water-reducing, high range admixtures
- Type G Water-reducing, high range, and retarding admixtures
- Type S Specific performance admixtures  
(e.g. slump retaining admixtures, used to improve and extend workability time of freshly mixed concrete without negative effect on setting times)

**ASTM C979 Standard Specification for Pigments for Integrally Colored Concrete** covers the basic requirement for colored and white pigments in powder form to be used as admixtures in concrete for the purpose of producing integrally colored concrete.

Where the pigments are a constituent of a multi component admixture, this specification applies to the pigment constituent of the admixture. This specification does not include the determination of pigment stability when elevated temperature using low-pressure (atmospheric) or high-pressure (autoclave) steam is used to accelerate the curing process. Cement (either Type I or Type II), aggregates, and admixtures materials shall be subjected to the following test methods: water wettability; alkali resistance; percentage of sulfates; water solubility; atmospheric curing stability; light resistance; effects on concrete, which include preparation of mixtures, making and curing, time of setting, air content, and compressive strength; and color match of shipment.

**ASTM C1622 Standard Specification for Cold-Weather Admixtures Systems** covers cold-weather admixture systems to be added to hydraulic-cement concrete when the temperature of the concrete immediately after placement will be low.

This specification stipulates tests of the cold-weather admixture system with suitable materials specified or with materials proposed for specific work, and provides three levels of testing. The apparatus used shall be suitable for low temperature environment. The concrete, cementitious materials, aggregates, and air-entraining admixture shall be tested and shall conform to the values of chemical and performance requirements such as initial setting time, compressive strength, shrinkage, durability.

### 3.3.3 POLYCARBOXYLATE ETHER TECHNOLOGY

The major characteristic of polycarboxylate ether-based superplasticizer technology is its targeted polymer design to achieve specific concrete properties. The mode of action is based on the adsorption of the PCE onto the cement grain and dispersion of the particles by electrostatic repulsion and steric hindrance.

Characteristics that can be influenced are:

- Adsorption speed
- Water reduction with high initial liquefaction / workability
- Slump retention without retardation and subsequent fast strength development
- Early strength development with sufficient workability time
- Stickiness
- Stability / viscosity

Various combinations of these properties can be optimized. The polymers consist of backbones with carboxyl groups and side chains.

The first component – backbone with carboxyl groups – is responsible for the attainable water reduction / initial slump and mixing time respectively. The second one – side chains – determines the slump keeping capability of the superplasticizer, affected by an increasing number of side chains. The crucial factor is the limited space for carboxyl groups and side chains along the backbone. Either a carboxyl group or side chain can be attached at a certain location. Basically variations in those factors lead to three generic types of polymers: water reducing, slump controlling and slump retaining polymers.

# Polymer Structure PCE

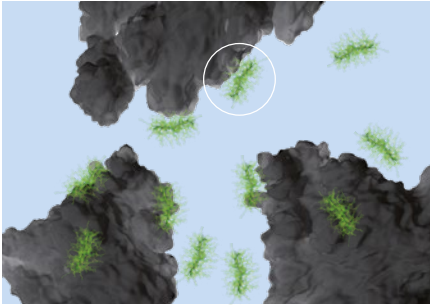
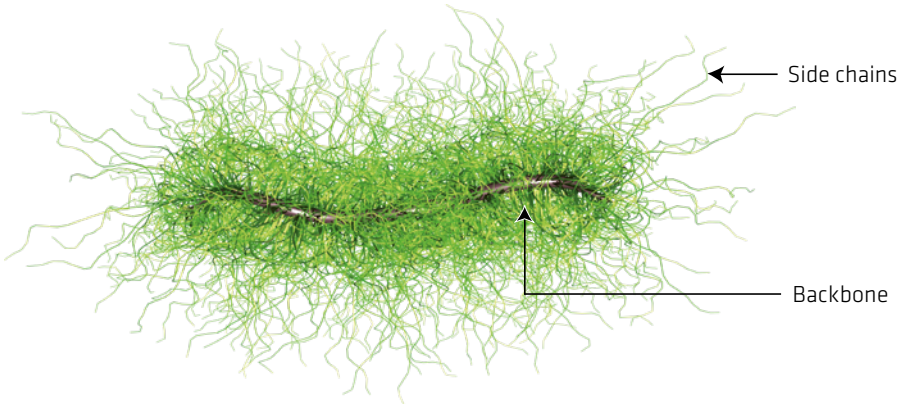

Adsorption of the polymer (backbone) on the cement grain.

Improved workability due to steric hindrance.

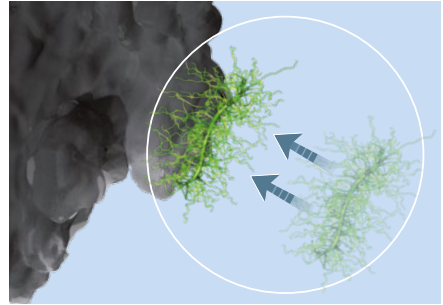

Detail of the adsorption of the polymer (backbone) on the cement grain.

Detail of improved workability due to steric hindrance.

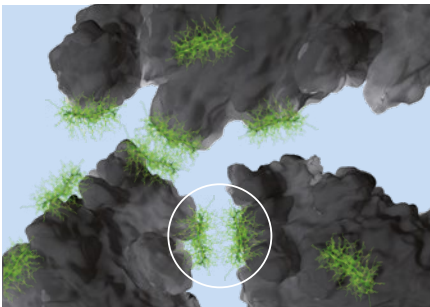
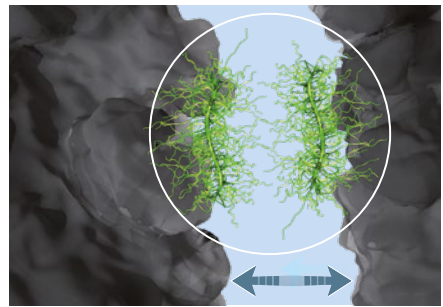

Fig. 3.3.2. Mode of action: PCE



It is possible to design a PCE with a large number of carboxyl groups and consequently low number of side chains, leading to high water reduction and shorter slump life of the concrete (Water Reducing ViscoCrete® Polymer).

Another possibility is to have a large number of side chains resulting in lower water reduction and longer slump life. These type of PCE work by creating a certain depot effect which results in an extended slump retention (Slump Retaining ViscoCrete® Polymer).

The third possibility is to design PCE which are able to change their structure in concrete over time. This special behavior causes a delayed dispersion effect. Such kind of specifically designed polymer can be used for slump controlling (Slump Controlling ViscoCrete® Polymer).

The Sika® ViscoCrete® technology offers more than the possibility to design PCE polymers with specific properties. It enables combination of various polymers to exploit the potential of each one. This compatibility is a major advantage of Sika® ViscoCrete® technology: tailor made solutions can be developed and adapted to the performance of the concrete mix. Moreover, final products can be optimized regarding the local market requirements to yield the best cost-performance solution.

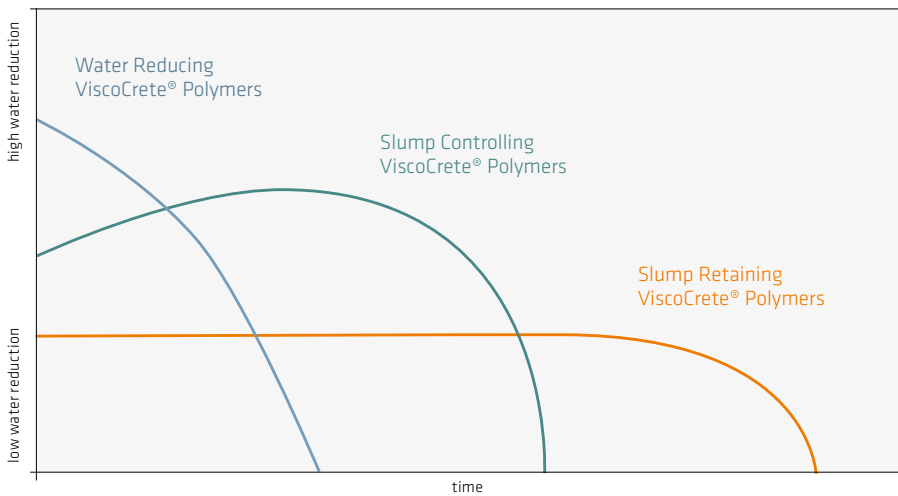

Fig. 3.3.3: Sika® ViscoCrete® Product Technology

### 3.3.4 SIKA PRODUCTS

Brand name	Product type
<b>SikaControl® AER</b>	Air-entrainer
<b>Sika® Antisol®</b>	Curing agent
<b>SikaRapid® Antifreeze</b>	Cold weather concreting admixture
<b>SikaColor®</b>	Concrete colors
<b>SikaControl® SRA</b>	Shrinkage reducer
<b>SikaControl® ASR</b>	Admixture to control Alkali-Silica-Reaction in concrete
<b>Sika® FerroGard®</b>	Corrosion inhibitor
<b>SikaFiber®</b>	Micro synthetic, macro synthetic or steel fiber
<b>SikaFume®</b>	Silica fume
<b>Sika® Stabilizer Lightcrete</b>	Foaming admixture
<b>Sikament®</b>	Superplasticizer
<b>SikaPaver®</b>	Compaction aid / anti-efflorescence admixture
<b>SikaControl® PerFin</b>	Concrete surface improver
<b>SikaPlast®</b>	Superplasticizer
<b>Sika® Plastiment®</b>	Plasticizer / water reducer
<b>Sika® Plastocrete®</b>	Plasticizer / water reducer
<b>Sika® Stabilizer Poro</b>	Foam formers
<b>Sika® Stabilizer Pump</b>	Pumping agent
<b>SikaRapid®</b>	Concrete accelerator
<b>Sika® Rugasol®</b>	Surface retarder
<b>Sika® Separol®</b>	Mold release agent
<b>Sika® Sigunit®</b>	Shotcrete accelerator
<b>Sika® Stabilizer VMA</b>	Viscosity modifying agent
<b>SikaTard®</b>	Concrete and Shotcrete retarder
<b>Sika® ViscoCrete®</b>	Superplasticizer
<b>Sika ViscoFlow®</b>	Workability enhancing admixture
<b>SikaControl® WT</b>	Water resisting admixture
<b>Sika® Stabilizer VMC</b>	Special stabilizing admixture



## 3.4 CONCRETE ADDITIONS AND SUPPLEMENTARY CEMENTITIOUS MATERIALS (SCM)

### 3.4.1 SCM ACCORDING TO EUROPEAN STANDARD

Concrete additions are defined as finely divided materials used in concrete in order to improve or to obtain desired fresh and hardened concrete properties. EN 206 lists two types of inorganic additions:

- Inert additions (type I)
- Pozzolanic or latent hydraulic additions (type II)

#### Type I

Virtually inactive materials such as lime fillers, quartz dust and color pigments.

- Rock flours (quartz dust, powdered limestone)

Low fines mixes can be improved by adding rock flours. These inert materials are used to improve the grading curve. The water requirement is higher, particularly with powdered limestone.

- Pigments

Pigmented metal oxides (mainly iron oxides) are used to color concrete. They are added at levels of 0.5 – 5% of the cement weight; they must remain color-fast and stable in the alkaline cement environment. With some types of pigment the water requirement of the mix can increase.

#### Type II

Pozzolanic or latent hydraulic materials such as natural pozzolans (trass), fly ash and silica dust as well as ground granulated blast furnace slag.

Fly ash is a fine ash from coal-fired power stations which is used as an additive for both cement and concrete. Its composition depends mainly on the type of coal and its origin and the burning conditions (EN 450).

Silica dust (Silica fume) consists of mainly spherical particles of amorphous silicon dioxide from the production of silicon and silicon alloys. It has a specific surface of 18 – 25 m<sup>2</sup> per gram and is a highly reactive pozzolan (EN 13263).

Standard dosages of silica dust are 5% to 10% max. of the cement weight.

Specifications and conformity criteria for ground granulated blast-furnace slag for use in concrete, mortar and grout are regulated in EN 15167-1.

### 3.4.2 SCM ACCORDING TO ASTM STANDARD

According to ASTM regulations supplementary cementitious materials (SCM) are defined as:

Fly ash and raw or calcined natural pozzolan	ASTM C618
Ground granulated blast-furnace slag	ASTM C989
Silica Fume	ASTM C1240

**ASTM C618 Standard Specification for Coal Fly Ash and Raw or Calcined Natural Pozzolan for Use in Concrete** covers coal fly ash and raw or calcined natural pozzolan for use in concrete where cementitious or pozzolanic action, or both, is desired, or where other properties normally attributed to fly ash or pozzolans may be desired, or where both objectives are to be achieved.

Fly ash and natural pozzolans shall conform to the prescribed chemical composition requirements and physical requirements. The materials shall be tested for fineness, strength activity index, water requirement, soundness, and autoclave expansion or contraction.

**ASTM C989 Standard Specification for Slag Cement for Use in Concrete and Mortars** covers three strength grades of finely ground granulated blast-furnace slag (Grades 80, 100, and 120) for use as a cementitious material in concrete and mortars.

The slag shall contain no additions and shall conform to the sulfide sulfur and sulfate chemical composition requirement. Physical properties of the slag shall be in accordance with the requirements for fineness as determined by air permeability and air content, slag activity index, and compressive strength.

**ASTM C1240 Standard Specification for Silica Fume Used in Cementitious Mixtures** covers silica fume for use in concrete and other systems containing hydraulic cement.

The material shall be composed of silica fume, mostly of amorphous silica. Test methods for chemical analysis, moisture content and loss on ignition, bulk density, specific surface, air entrainment of mortar, strength activity index, reactivity with cement alkalis, and sulfate resistance of silica fume shall conform to this specification. Physical tests shall include determining the specimen's density and the specific surface by utilizing the BET, nitrogen adsorption method. Silica fume shall be stored in such a manner as to permit easy access for the proper inspection and identification of each shipment.

## 3.5 FIBERS

Fiber reinforced concrete is concrete to which fibers have been added during production to improve its cracking and fracturing behavior. After many years of research and development, fiber reinforced concrete is now fully established in the market for its important advantages.



The addition of suitable fibers can provide significant improvements in the properties of your concrete, including:

- Less cracking due to early-age shrinkage
- Better cohesion in the fresh concrete
- Higher flexural and shear strengths
- Improved load capacity and ductility
- Increased abrasion resistance
- Protection against freeze-thaw attack
- Spalling resistance at high temperatures



There are three main components which help the fiber performance.

### 1. Tensile Strength and E-Modulus

Cracks can occur at different times in the concrete, mainly in the beginning and during the hardening process, where it is mainly early-age shrinkage cracking up to 24 hours. Fibers reduce cracks during the hardening process through their tensile strength and extensibility. Where there are greater acting forces, fibers prevent larger cracks by dissipating the strains into more numerous fine and less harmful cracks. If cracking occurs in the concrete then the E-modulus of the fibers is crucial, as this defines the resistance of the fibers to counteract the elastic deformation.

### 2. Anchorage

In order to transfer the forces between the cracked concrete and the fiber it is important to demonstrate there is sufficient bond, or anchoring, between the fiber and matrix material. This can be done in different ways with the shape or texture of the fiber.

### 3. Aspect ratio

This is the relationship between the length and the equivalent diameter of the fiber. For a good anchorage and a good performance in the hardened concrete a long and thin fiber would be good. The fiber would be nicely embedded and would not slip out. On the other hand if the fiber to matrix bond is too good it can result in fiber rupture. Fiber rupture is when the tensile strength of the fiber is exceeded.

Fibers are easy to handle and dose, when mixed properly they distribute homogenously and have a good bond, making the concrete more cohesive. This makes fibers ideal for improving the performance of concrete and mortar for many applications.

### 3.5.1 CLASSIFICATION OF FIBERS

#### Europe

In Europe, fibers for concrete are covered by EN 14889-1 and 2 definitions specifications and conformity.

EN 14889-1 steel fibers are classified into one of the following groups:

Group I	Cold-drawn wire
Group II	Cut sheet
Group III	Melt extracted
Group IV	Shaved cold drawn wire
Group V	Milled from blocks

EN 14889-2 Polymer fibers are characterized by the manufacturer according to their physical form:

Class Ia	Micro fibers < 0.3 mm in diameter. Mono-filamented
Class Ib	Micro fibers < 0.3 mm in diameter. Fibrillated
Class II	Macro fibers > 0.3 mm in diameter

#### Americas

ASTM C1116/C1116M – 10a Standard Specification for Fiber-Reinforced Concrete and Shotcrete. This specification covers all forms of fiber-reinforced concrete mixed, delivered, sampled and tested at the point of delivery. This specification classifies fiber-reinforced concrete or shotcrete into 3 categories:

Type I	Steel fiber-reinforced concrete or shotcrete
Type II	Alkali-resistant glass fiber-reinforced concrete or shotcrete
Type III	Synthetic fiber-reinforced concrete or shotcrete

ASTM A820/A820M Standard Specification for Steel Fibers for Fiber-Reinforced Concrete covers minimum requirements for steel fibers intended for use in fiber-reinforced concrete.

There are five types of steel fibers.

- Pieces of smooth or deformed cold-drawn wire
- Smooth or deformed cut sheet
- Melt-extracted fibers
- Mill-cut
- Modified cold-drawn wire steel fibers

ASTM D7508/D7508M-20 Standard Specification for Polyolefin Chopped Strands for Use in Concrete covers polyolefin chopped strands (fibers) for use in concrete.

### 3.5.2 HOW TO SPECIFY FIBER-REINFORCED CONCRETE

There are different fibers for different concretes depending on the required performance. The two main types of fibers are micro and macro fibers, defined by their diameter according to European Standards. Micro synthetic fibers are generally used for reducing spalling in high temperatures and crack reduction. Thicker macro synthetic or steel fibers are generally used to increase the mechanical performances of hardened concrete. Sika is a full range supplier of fibers, and other special types and blends of fibers.



#### Synthetic macro-fibers

Synthetic macro-fibers have a lower E-modulus than steel fibers (5 – 15 GPa). Unlike steel fibers, synthetic macro-fibers cannot take extremely high loads, but they work extremely effectively in the early phases of hardening to prevent and/or reduce the size of cracks developing in the concrete. They are corrosion resistant and give the concrete greater ductility. Synthetic fibers have more fibers per kg to balance the high e-modulus of steel fibers.



#### Steel fibers

Steel fibers are characterized by high E-modulus (200 GPa) and high tensile strength (2500 MPa). They prevent creep of the concrete but do not counter-act early shrinkage. Corrosion does not cause spalling of the concrete, just a change of color on the concrete surface. Protruding steel fibers can pose a risk of injury or damage to waterproofing membranes.



#### Synthetic micro-fibers

Synthetic micro-fibers have an even lower E-modulus (3 – 5 GPa) than synthetic macro-fibers. They are mainly used to reduce early-age shrinkage cracking and also to reduce concrete spalling at high temperatures due to their low melting point (160 °C). Again these synthetic micro-fibers are non-corrosive.

### Best use of the different types of fibers

State of concrete or mortar	Effect /property improvement	Recommended fiber type
Fresh	Homogeneity improvement	Micro polypropylene fibers
Until about 12 hours	Early-age cracking reduction	Micro polypropylene fibers
1–2 days	Reduction of cracks induced by restraint or temperature	Micro & Macro polypropylene fibers
28 days hardening or more	Transmission of external forces	Macro polypropylene & Steel fibers
28 days hardening or more	Reduce concrete spalling at high temperatures	Micro polypropylene fibers

### 3.5.3 SikaFiber® RANGE

#### Steel Fibers



##### **SikaFiber® Novocon®**

- For shotcrete, slabs and precast
- Structural replacement of steel reinforcement

Dosage: 20 – 40 kg/m<sup>3</sup>

#### Macro Fibers



##### **SikaFiber® Force**

- For shotcrete, slabs and precast
- Replacement of steel reinforcement

Dosage: 3 – 8 kg/m<sup>3</sup>

#### Micro Fibers



##### **SikaFiber® PPM Sika® Fibermesh®**

- For reducing spalling at high temperatures shrinkage

Dosage: 0.6 – 2 kg/m<sup>3</sup>

## 3.6 WATER

The suitability of water for concrete production depends on its origin.

### 3.6.1 WATER ACCORDING TO EUROPEAN STANDARD

EN 1008 lists the following types:

■ **Drinking water**

Suitable for concrete. Does not need to be tested.

■ **Water recovered from processes in the concrete industry** (e.g. wash water)

Generally suitable for concrete but the requirements in Annex A of the standard must be met (e.g. that the additional weight of solids in the concrete occurring when water recovered from processes in the concrete industry is used must be less than 1% of the total weight of the aggregate contained in the mix).

■ **Ground water**

May be suitable for concrete but must be checked.

■ **Natural surface water and industrial process water**

May be suitable for concrete but must be checked.

■ **Sea water or brackish water**

May be used for non-reinforced concrete but is not suitable for reinforced or prestressed concrete. The maximum permitted chloride content in the concrete must be observed for concrete with steel reinforcement or embedded metal parts.

■ **Waste water**

Not suitable for concrete.

Combined water is a mixture of water recovered from processes in the concrete industry and water from a different source. The single requirements apply for the combined water type.

#### **Preliminary tests (EN 1008, Table 1)**

The water must first be analyzed for traces of oil and grease, foaming agents (detergents), suspended substances, odor (e.g. no odor of hydrogen sulphide after adding hydrochloric acid), acid content ( $\text{pH} \geq 4$ ) and humic substances.

Water which does not meet one or more of the requirements in Table 1 may only be used if it meets the following chemical specifications and its use does not have negative consequences for the setting time and strength development (see EN 1008 for test methods).

### 3.6.2 WATER ACCORDING TO ASTM STANDARD

**ASTM C1602 *Standard Specification for Mixing Water Used in the Production of Hydraulic Cement Concrete*** covers mixing water used in the production of hydraulic cement concrete.

It defines sources of water and provides requirements and testing frequencies for qualifying individual or combined water sources. Mixing water shall consist of: batch water, ice, water added by truck operator, free moisture on the aggregates and water introduced in the form of admixtures.

Potable and non-potable water is permitted to be used as mixing water in concrete. The following are concrete performance requirements for mixing water: compressive strength and time of set.

Density of water shall be tested or monitored with a hydrometer. Optional chemical limits for combined mixing water are given for: chloride, sulfate, alkalis and total solids.





# 4 CONCRETE MIX DESIGN

## 4.1 CONCRETE MIX DESIGN CALCULATION

### Material volume calculation

The purpose of the material volume calculation is to enable the batching and mixing of a concrete in general as well as special concrete types. The calculation assumes that the designed quantities of cement, water, aggregate, admixtures, additives, plus the voids after compaction, add up to a volume of  $1 \text{ m}^3$  of fresh concrete.

The proper design and material volume calculation leads to the fulfillment of all relevant standards, improves the quality of the concrete produced and opens the door to more economical solutions.

The fines content consists of:

- The cement and any concrete additive(s)
- The 0 to 0.125 mm granulometric fraction of the aggregate

The fines act as a lubricant in the fresh concrete to ensure the workability and water retention. The risk of mixture separation during installation is reduced and compaction is made easier.

However, fines contents which are too high produce doughy, tacky concrete. There can also be a greater shrinkage and creep tendency (higher water content).

The following quantities have proved best:

Table 4.1.1: Sika recommendation

	Round aggregate	Crushed aggregate
For concrete with a maximum particle size of 32 mm	Fines content between 350 and 400 $\text{kg}/\text{m}^3$	Fines content between 375 and 425 $\text{kg}/\text{m}^3$
For concrete with a maximum particle size of 16 mm	Fines content between 400 and 450 $\text{kg}/\text{m}^3$	Fines content between 425 and 475 $\text{kg}/\text{m}^3$

Higher fines contents are usually required for self-compacting concretes (SCC).

Usually the calculation starts by choosing a certain cement content and w/c-ratio (or binder content and w/b-ratio). By doing so, one can calculate the volume in liters of aggregates and sand. By application of a combined aggregate grading curve this volume is filled with sand and aggregates.

Table 4.1.2: Exemplary combined aggregates 0 – 32 mm:

Constituent	Particle size in mm	Content in mix in % (weight)
Sand	0 – 4	48.0
Gravel	4 – 8	12.0
Gravel	8 – 16	20.0
Gravel	16 – 32	20.0

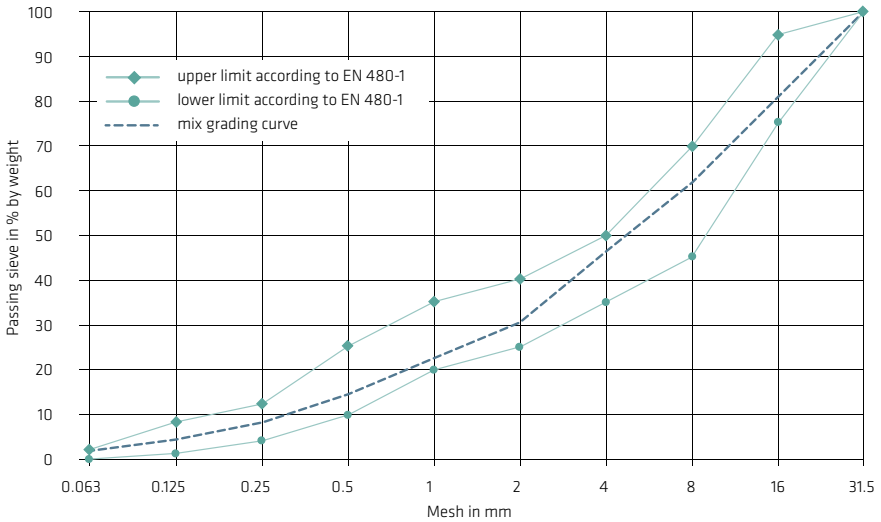

Fig. 4.1.1: Particle size distribution (grading curve range according to EN 480-1)

If the sand and gravel are washed, filler has to be added to improve the stability and overall consistence of the concrete mix.

There are several methods to design concrete mixes. One of the most common and popular method used to design concrete mixes is the "Absolute Volume Method".

### Concrete mix design by Absolute Volume Method:

Table 4.1.3: Calculation volumes and mass for 1 m<sup>3</sup> of concrete

Raw material used for designed concrete	Dosage [%]	kg for 1 m <sup>3</sup> (according to mix design)		Spec. density [kg/L]		Yields liters for 1 m <sup>3</sup>
<b>Cement</b> Type: CEM I		kg	325	3.15 (check locally)	→	<b>103</b>
<b>Additive Silica fume</b> (additional binder)	6	kg	19.5	2.2 (check locally)	→	<b>9</b>
<b>Admixture</b> Type: Sika® ViscoCrete® (calc. on cement + silica fume)	1.2	kg	4.13			(incl. in water)
<b>Air expected or planned</b> 1% ≙ 10 L in 1 m <sup>3</sup>		%	3.0	-	→	<b>30</b>
<b>Mixing water</b> w/c = 0.48 (including water content aggregates) w/c <sub>eq.</sub> = 0.45		kg	156	1.0	→	<b>155</b>
<b>Total volume in liters without aggregates</b>						<b>297 ↓</b>
<b>Aggregates</b> (in dry state)		kg	1'863	2.65 (check locally)	←	<b>703</b> (= Δ for 1'000 L)
<b>Total concrete</b>		kg	2'362 (for 1 m <sup>3</sup> )	2'362 kg/m <sup>3</sup> (spec. density of fresh concrete)		<b>1'000 L (= 1 m<sup>3</sup>)</b>

→ = way of calculation

**Remark:** If total amount of admixture(s) exceeds 3 L/m<sup>3</sup> of concrete, water content of admixture(s) has to be included in calculation of w/c-ratio.

## Aggregates and Batching Water

Aggregates used in concrete production can have different effects on the dosing water, depending on the aggregate's nature and source as well as the environmental conditions. The interaction of the aggregates with the batching water results from the water content of a possible porosity of the aggregates as well as from additional water on the surface of wet aggregates. Both effects must be considered accordingly in the mix design.

Capillary porosity of aggregates leads to water adsorption effects. If the pores are water-saturated, this water must not be considered regarding calculation of the w/c-ratio. In case of partly or completely dry aggregates, however, some batching water would be immediately adsorbed by this aggregate porosity until this is saturated, the mix would stiffen, and the total batching water would have to be accordingly increased. On the other hand, the aggregates are often wet and carry additional water on their surface, which contributes to the total batching water, thus increasing the w/c-ratio.

Three extreme scenarios regarding the mix design can be defined in terms of aggregates as illustrated in Figure 4.1.2. Mix design calculation is based on the SSD data, whereby the total amount of water introduced by the used aggregates (surface moisture is variable) and their absorption water have to be known and considered.

### Oven Dry (OD)

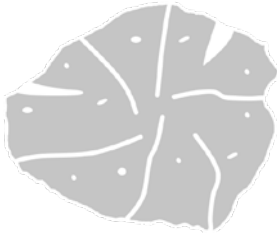

No water

Aggregates are completely dry (outer surface and capillary pores):

- Concrete consistency will be more stiff than designed
- Concrete requires more water than calculated from the w/c-ratio until the pores are water-saturated

### Saturated Surface Dry (SSD)

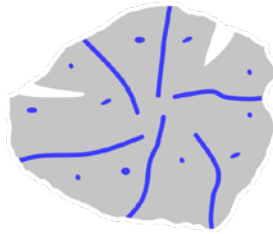

Absorption water

Capillary pores are water-saturated and the outer surface is dry:

- Concrete consistency will be as designed
- Concrete requires batching water as calculated from the w/c-ratio

### Surface Wet

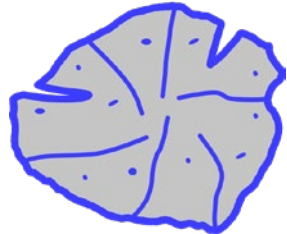

Absorption water  
Surface moisture

Capillary pores are water-saturated and the outer surface is wet:

- Concrete consistency will be more fluid than designed
- Concrete requires less batching water than calculated from the w/c-ratio due to the additional water on the aggregate surface

Fig. 4.1.2: Moisture states of aggregates in concrete

## 4.2 DESIGN CONCEPT PASTE VOLUME

This section 'Design Concept Paste Volume' is related to the findings of Abrams, that the compressive strength of concrete, as the central material property, mainly depends on the w/c-ratio. This holds true for all concretes with a w/c-ratio greater than 0.35, which is the case for most concretes. This requirement is the basis for the following explanations and conclusions of the design concept volume paste.



*Cement mortar paste includes all binders, powder additives and the free water (not absorbed by the aggregates). Fine mortar paste includes in addition also all fine parts of the aggregates  $\leq 0.125$  mm.*

The requirements for every type of concrete placing will vary regarding the fine fraction portion of the concrete mix design. Along with this of course the larger components play a role, but this is of considerably lesser significance. The coarse grains form primarily the scaffolding and serve as filling material. On the basis of innumerable concrete mix designs over many decades, ranges of fines content and mortar quantities can be indicated for various types of installation, which lead to a correct result also with differing aggregate components, or take these fluctuations into consideration, respectively.

*Table 4.2.1: Fine mortar paste for different concrete types*

Placing method	Fines content	Fine mortar paste	Remarks
Crane & Bucket Concrete	-	250 to 280 L/m <sup>3</sup>	The fine mortar paste contains: cement, powder additives, fines from sand $\leq 0.125$ mm + water
Pumped concrete	> 375 kg/m <sup>3</sup> with max. grain 32 mm	280 to 320 L/m <sup>3</sup>	
Self-compacting concrete (SCC)	> 500 kg/m <sup>3</sup> with max. grain 16 mm	320 to 380 L/m <sup>3</sup>	

For a defined fine mortar quantity, fines content and w/c-ratio, the quantity of fines can be established depending on the durability requirements.

- Physical demands of the concrete (compressive strength, flexural, tensile, early strength)
- Demands on durability (e.g. impermeability, sulfate resistance, AAR)
- Demands on processing (structure of fines, granular form and reactivity)
- Local and regional availability (especially for sand and binders)
- Costs (material costs and transport costs)
- Transport distances
- Sustainability due to type of material, processing or transport of components

The proper fine mortar quantity

Considering that the cement content does not play a role in achievement of the required strength (Abrams), then the necessary or correct quantity of cement must be established via other criteria:

- Achievement of the planned concrete processing (fines content and cement paste)
- Achievement of required durability properties (resistance to external influences)

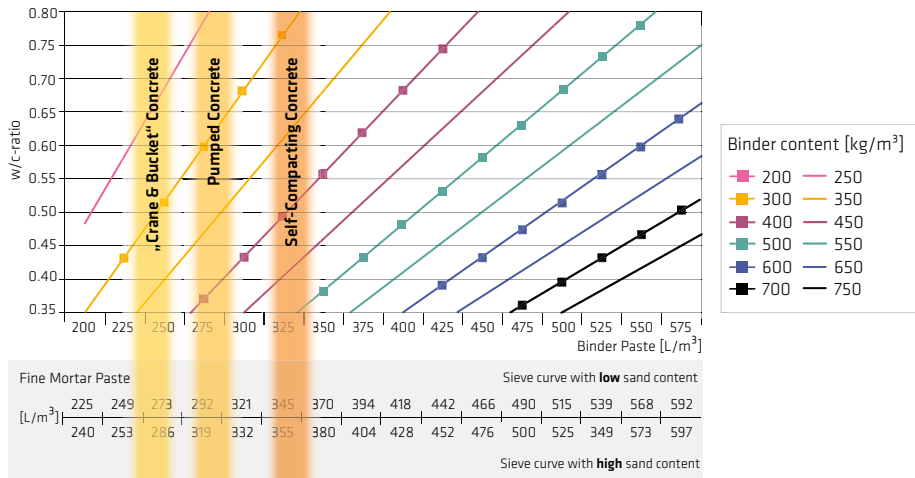

Fig. 4.2.1: Relation between concrete compressive strengths of a specific cement, expressed in w/c-ratio, and the fine mortar quantity (L/m³) for a required cement content (kg/m³)

In both cases it is possible to replace a certain amount of cement by substitute materials and thereby to influence the material balance (costs / concrete technology / ecology) in a positive way. The pumpability, for example, can be enhanced through the use of good limestone powder or fly ash. High pressure or abrasion resistance results from addition of silica fume, or the increase of sulfate resistance due to the use of granulated slag. Depending on the properties of a specific cement type, its relation between strength and the minimum required fine mortar paste can be represented as such.

Based on the local cement or binder type the strength related to the w/c-ratio has to be defined. Based on that finding the Fig. 4.2.1 shows the required fine mortar paste volume. The specific amount of fines has to be adjusted with the local available sand and powder additives.

### **The balanced fine mortar quantity**

To achieve both good workability and concrete properties, the fine mortar and thus above all cement paste should be limited to a quantity that allows the building material to be installed properly and in accordance with requirements. A range of advantages are achieved with such a measure:

- Concrete technology: lowest possible volume of hydration products, meaning also low shrinkage and heat development in all phases
- Commercially: targeted, economical use of cements and SCM reduces the cost of the overall mix design
- Ecologically: through substitution of cement with SCM the ecological balance (LCA) turns out considerably more positive



*Fig. 4.2.2: Mix design ingredients of concrete: Coarse aggregates, water, cement, superplasticizer, sand (from left to right)*





## 4.3 SIKA MIX DESIGN TOOL

The proper design of concrete is a decisive step in concrete production and for the evaluation of concrete performance in fresh and hardened state. In addition the exchange of concrete recipes and discussion of certain measures to improve concrete mix designs is a daily challenge for anybody involved in concrete business.



The main goal of the Sika Mix Design Tool is a complete mix design calculation. A data base for the raw materials and the projects / customers is part of the tool in order to provide mix design calculation in an efficient way. The possibility to define different currencies, units and languages should enable the utilization of the tool on a worldwide base.

**For every user it is mandatory to first read the manual, because this sophisticated concrete mix design calculation program is not completely self explaining. It is worth investing some time to fully understand all included functions in order to explore all aspects of the program.**

The program navigation looks as follows:

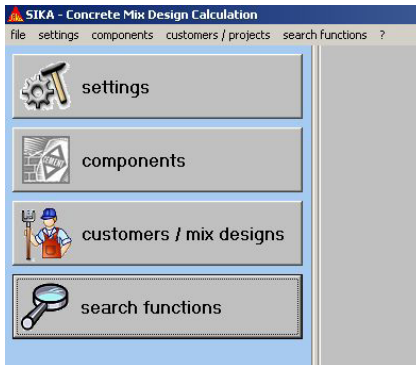
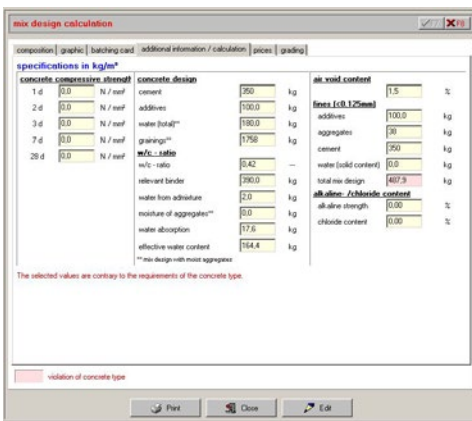

Fig. 4.3.1: Program navigation

- Preset of all relevant parameters like localization, units, currency
- Management of raw materials used in the concrete mix design calculation (cement, aggregates, additives and admixtures)
- Definition of customers and their projects in conjunction with any concrete mix calculation
- Dedicated search regarding a mix design or a specific key word





- Prediction of concrete compressive strength based on cement strength
- Detailed analyses of important fresh concrete parameters overall fines content
- Indication of concrete type requirements violation

Fig. 4.3.4: Analysis of important technical values as well an indication of concrete type

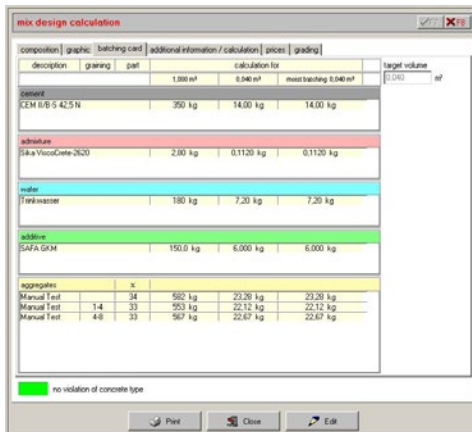

- Possibility to calculate different batch sizes
- Detailed quantities for individual components
- Suitable for laboratory mixes as well as large scale plant trials

Fig. 4.3.5: Batchcard for laboratory testing and on site applications

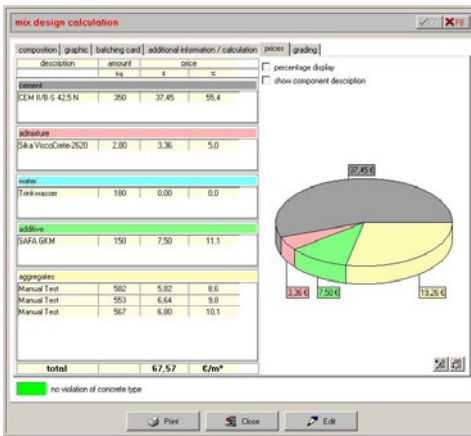

Fig. 4.3.6: Overview over the cost structure of a concrete mix

- Calculation of cost of a total cubic meter of concrete
- Calculation of cost of each individual component
- Graphic illustration of absolute cost per component as well as cost ratios

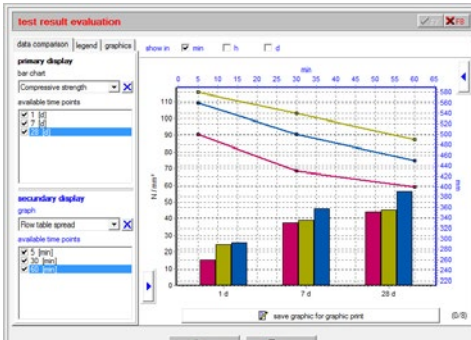

Fig. 4.3.7: Comparison of different concrete mixes with regard to fresh and hardened concrete characteristics

- Display of all fresh and hardened concrete characteristics
- Comparison of different concrete characteristics, like slump, air content, compressive strength etc.

# 5 FRESH CONCRETE PROPERTIES AND TESTS

## 5.1 WATER / CEMENT – RATIO

The water / cement-ratio ( $w/c$ ) is the water to cement weight ratio of the fresh concrete. It is calculated by dividing the weight of the total free water ( $w$ ) by the weight of the added cement ( $c$ ). The  $k$ -value is a concept explained in the EN 206 (see Chapter 11.1.5). The equation for the  $w/c$ -ratio is therefore:

$$w/c = \frac{W_{\text{eff}}}{c} \text{ or } \frac{W_{\text{eff}}}{c_{\text{eq}}} = \frac{W_{\text{eff}}}{c + (K \times \text{type II addition})} \quad [5.1.1]$$

The effective water content  $w_{\text{eff}}$  of a mix is calculated from the difference between the added water quantity  $w_0$  in the fresh concrete and the water quantity absorbed of the aggregates ( $w_G$ , determined according to EN 1097-6) or the humidity of the aggregates  $w_h$  respectively.

$$W_{\text{eff}} = W_0 - W_G + W_h \quad [5.1.2]$$

The water content required is influenced by the aggregates used, round or crushed material, and their composition.

The choice of the  $w/c$ -ratio is determined principally by the environmental influences (exposure classes) according to EN 206.

Two methods to evaluate the water content in a concrete are used. The basic principle is to evaporate the water by kiln drying. The test can be done either by a gasburner or a microwave.



### 5.1.1 PAN TESTING METHOD

The weight of the pan for water content testing has to be measured in the first step (a). A mass of approx. 10 kg (for test accuracy) of concrete (b) has to be placed in the pan. After 20 minutes of heating the pan, the weight of the pan with the dried concrete (c) has to be measured. The difference between a+b and c is the water content in the concrete.

To make sure that the concrete is dry weight it after 20 minutes, dry it again for 5 minutes and weight again. If the difference is below 5 g the concrete is dry by definition.

For the measurement of the fresh concrete density please see Chapter 5.6.

Calculation:

Water content:

$$w_0 = (m_0 - m_1) * \rho / m_0 \quad [\text{kg}/\text{m}^3] \quad [5.1.3]$$

w/c-ratio:

$$(w_0 - w_c) / c \quad [5.1.4]$$

$\rho$ fresh concrete density [ $\text{kg}/\text{m}^3$ ]	$m_0$ sample wet [kg]	$w_c$ absorbed water [ $\text{kg}/\text{m}^3$ ]
$c$ cement content [ $\text{kg}/\text{m}^3$ ]	$m_1$ sample dry [kg]	$w_0$ water content [ $\text{kg}/\text{m}^3$ ]

### 5.1.2 MICROWAVE TESTING METHOD

The microwave testing method for water content of fresh concrete is based on an Austrian norm. The maximal grain size for this test is 32 mm. The time between the mixing and the testing of the concrete shall not exceed 90 minutes. Furthermore the test shouldn't be used with steel fiber reinforced concrete.

For this test an amount of approx.  $2'000 \pm 100$  g of fresh concrete is needed and has to be evenly distributed on the testing plate. The weight ( $m_f$ ) of the concrete and the plate has to be measured with a scale with an accuracy of  $\Delta \pm 1$ g. Figure 5.1.1 shows the minimal kiln drying time according to the power of the microwave. After that time the weight of the plate with the dried concrete shall be measured and after that kiln dried in the microwave for another two minutes. The current weight and the measured weight shall not exceed a difference of 5 g. Else the sample has to be dried again.

$$w_0 = \frac{m_f - m_{dry}}{m_f} * 100\% \quad [5.1.5]$$

$w_0$  water content [%]

$m_f$  weight of sample of fresh concrete inclusive testing plate

$m_{dry}$  weight of sample of dried concrete inclusive testing plate

The density of water is set at  $\rho_{water} = 1'000 \text{ kg/m}^3$

Based on the calculated water content in % and the density of the fresh concrete the water content in  $\text{kg/m}^3$  can be calculated according to equation 5.1.6:

$$w_{(\text{kg/m}^3)} = w_0 * \rho / 100 \quad [5.1.6]$$

$w_{(\text{kg/m}^3)}$  water content [ $\text{kg/m}^3$ ]

$w_0$  water content [%]

$\rho$  fresh concrete density [ $\text{kg/m}^3$ ]

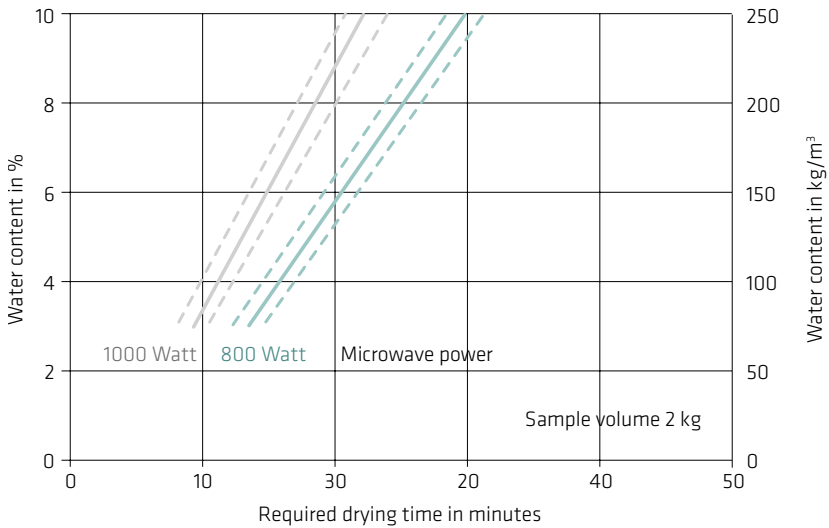

Fig. 5.1.1: Water content /drying time

## 5.2 WORKABILITY AND CONSISTENCE

The consistence defines the behavior of the fresh concrete during mixing, handling, delivery and placing on site and also during compaction and surface smoothing. Workability is therefore a relative parameter and is basically defined by the consistence.

### Workability requirements

- Cost effective handling, pouring / placing and finishing of the fresh concrete
- Maximum plasticity ('flowability'), with the use of superplasticizers
- Good cohesion
- Low risk of segregation, good surface smoothening ('finishing properties')
- Extended workability → Retardation/hot weather concrete
- Accelerated set and hardening process → Set and hardening acceleration / cold weather concrete

The consistence – or deformability – of the fresh concrete can be measured. Standard EN 206 differentiates between 4 and 6 consistence classes dependent on the test method and defines fresh concretes from stiff to fluid.

The consistence tests are generally among the concrete control parameters which are established in preliminary tests for the applications involved.

### Factors influencing consistence

- Aggregate shape and composition
- Cement content and type
- Water content
- Use of additives
- Use of concrete admixtures
- Temperature conditions
- Mixing time and intensity
- Time of measurement

### Time and place of tests

The consistence of the concrete should be determined at the time of delivery, i.e. on site before placing (monitoring of workability).

If the consistence is recorded both after the mixing process (production consistency check) and before installation on site, a direct comparison of the change in consistence as a factor of the fresh concrete age is possible.

If the concrete is delivered in a ready-mix truck, the consistence may be measured on a random sample taken after about 0.3 m<sup>3</sup> of material has been discharged.



## Testing the consistence

'Workability' means the behavior of the fresh concrete during mixing, handling, delivery and placement at the point of placing and then during compaction and finishing of the surface. It is a measure of the deformability of the fresh concrete. It is defined by measurable numbers.

Standard EN 206 divides consistence into 4 to 6 classes depending on the testing method. They can be used to specify and test a stiff to almost liquid consistence.

Testing the consistence by

- Slump test (see Page 69)
- Degree of compactability (see Page 70)
- Flow table spread (see Page 71)

Consistence tests are used for regular monitoring of the fresh concrete. The test frequency should be based on the importance of the structure and arranged so that a given concrete quality can be obtained consistently.

Chapter 11 of EN 206 gives detailed information on these conformity controls.

*Table 5.2.1: Tolerances for target consistence values according to EN 206*

Test method	Degree of compactability			Flow table spread (FTS)	Slump		
	$\geq 1.26$	1.25 ... 1.11	$\leq 1.10$		$\leq 40$ mm	50 ... 90 mm	$\geq 100$ mm
Target value range	$\geq 1.26$	1.25 ... 1.11	$\leq 1.10$	All values	$\leq 40$ mm	50 ... 90 mm	$\geq 100$ mm
Tolerance	$\pm 0.10$	$\pm 0.08$	$\pm 0.05$	$\pm 30$ mm	$\pm 10$ mm	$\pm 20$ mm	$\pm 30$ mm

## Testing the consistence by the slump test

### Principle:

The fresh concrete is placed in a hollow cone-shaped form and compacted. When the form is raised, the slump gives a measure of the concrete consistence. The slump is the difference in mm between the height of the form and the height of the fresh concrete cone out of the form.

### EN 12350-2

The whole process from the start of pouring to rising of the form must be carried out within 150 seconds. The test is only valid if it gives a residual slump in which the concrete remains largely intact and symmetrical after removal of the form, i.e. the concrete remains standing in the form of a cone (or body resembling a cone). If the concrete collapses, another sample must be taken. If the specimens collapse in two consecutive tests, the concrete does not have the plasticity and cohesion required for the slump test.

### Measurement of slump

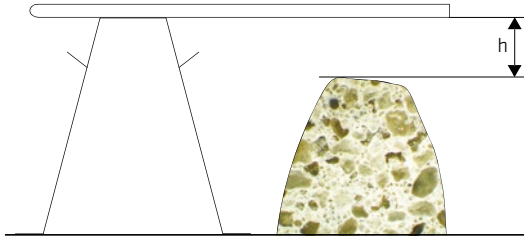

Fig. 5.2.1: Measurement of slumps

### Forms of slump

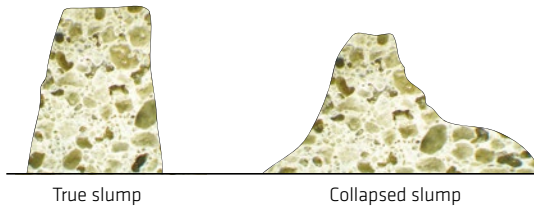

Fig. 5.2.2: Forms of slumps

Slump classes: see Chapter 11.1.3, Classification by consistence, Page 251

## Testing the consistence by degree of compactability

### Principle:

The fresh concrete is placed carefully in the steel test container. Compaction must be avoided. When the container is full, the concrete is smoothed flush towards the edge without vibration. The concrete is then compacted, e.g. with a poker vibrator (max. bottle diameter 50 mm). After compaction the distance between the concrete surface and the top of the container is measured at the center of all 4 sides. The mean figure ( $s$ ) measured is used to calculate the degree of compactability.

### EN 12350-4

Container dimensions	Base plate	200 × 200 mm	(±2 mm)
	Height	400 mm	(±2 mm)

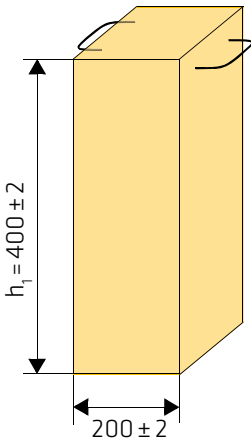
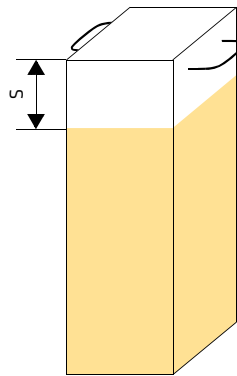

Fig. 5.2.3: Concrete in container before compaction



Dimensions in millimeters

Fig. 5.2.4: Concrete in container after compaction

Degree of compactability: 
$$c = \frac{h_1}{h_1 - s} \text{ (non-dimensional)} \quad [5.2.1]$$

Degree of compactability classes:  
see Chapter 11.1.3, Classification by consistence, Page 251

## Testing the consistence by flow table test

### Principle:

This test determines the consistence of fresh concrete by measuring the flow of concrete on a horizontal flat plate. The fresh concrete is first poured into a cone-shaped form (in 2 layers), compacted and smoothed flush with the top of the form. The form is then carefully removed vertically upwards. At the end of any concrete collapse, the plate is raised manually or mechanically 15 times up to the top stop and then dropped to the bottom stop. The concrete flow is measured parallel to the side edges, through the central cross.

### EN 12350-5

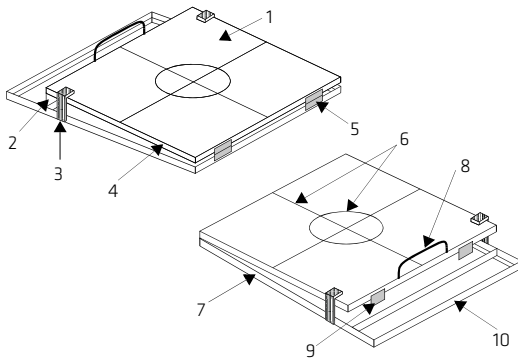

- |  |               |
|--|---------------|
| 1 Metal plate                          | 6 Marking     |
| 2 Lift height (limited to $40 \pm 1$ ) | 7 Frame       |
| 3 Topstop                              | 8 Handle      |
| 4 Impact place                         | 9 Bottom stop |
| 5 Hinges (outside)                     | 10 Foot rest  |

Fig. 5.2.5: Flow table

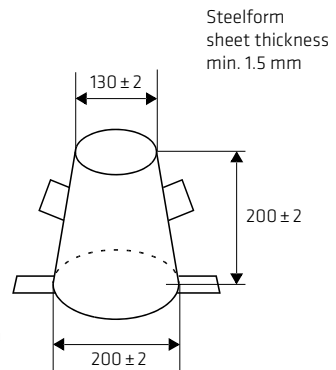

Fig. 5.2.6: Slump cone

Flow diameter classes:

see Chapter 11.1.3, Classification of consistence, Page 251

## Testing the consistence by slump-flow test and $t_{500}$

### Principle:

This test determines the consistence of fresh concrete (SCC) by measuring the flow of concrete on a horizontal flat plate. The fresh concrete is first poured into a cone-shaped form (cone similar to the one used for slump testing). The form is then carefully removed vertically upwards. The concrete flow is measured by the largest diameter of the flow spread and then the diameter of the flow spread at right angles to the first measure. If the difference between both measures is greater than 50 mm another sample shall be taken and the procedure repeated. On the plate a ring with 500 mm diameter from the center is marked. The time measured from lifting the cone until the first contact of the flowing concrete and that ring is the so called  $t_{500}$  time.

### EN 12350-8

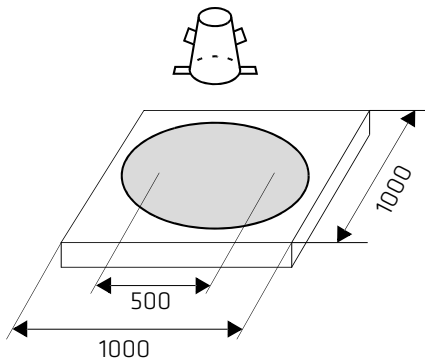

Fig. 5.2.7: Slump-flow test (dimensions in mm)

An alternative method which can be found sometimes is to invert the slump cone. This makes the work easier, as the form does not have to be held while pouring.

This method is suitable for both site and laboratory use.

Further obstacles can be added by placing a ring of steel (J-ring) with serrated steel in the center, to simulate the flow behavior around reinforcement.

## Testing the consistence by L-Box test

### Principle:

This test determines the consistence of fresh self-compacting concrete by measuring the flow of concrete in a L-box. The fresh concrete is first poured in the box. After lifting the barrier the concrete flows into the box. The height at the vertical section and the height at the end of the horizontal section is measured. The ratio of these heights is a measure of the passing or blocking behavior of the self-compacting concrete.

Two variations of this test are usually used: the two bar test and the three bar test. The three bar test simulates more congested reinforcement.

### EN 12350-10

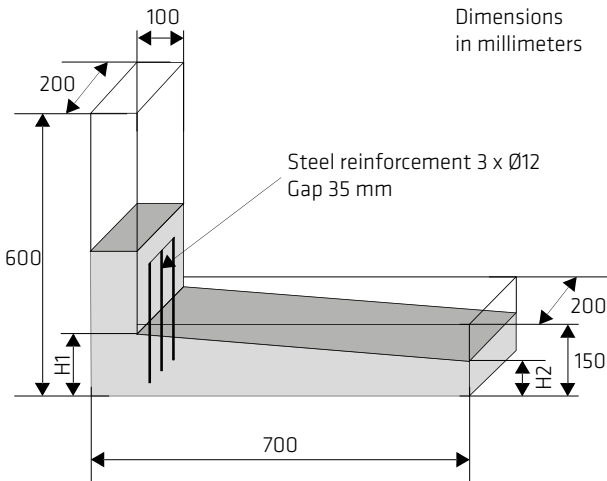

Fig. 5.2.8: L-Box test

## Testing the consistence by V-Funnel test

### Principle:

This test determines the consistence of fresh self-compacting concrete by measuring the flow of concrete in a V-funnel. The fresh concrete is first poured in the V-funnel. After opening the barrier the concrete flows out of the V-funnel. The time measured from opening the barrier until the V-funnel is empty is recorded as V-funnel time. This test gives an indication about the viscosity and filling ability of self compacting concrete.

### EN 12350-9

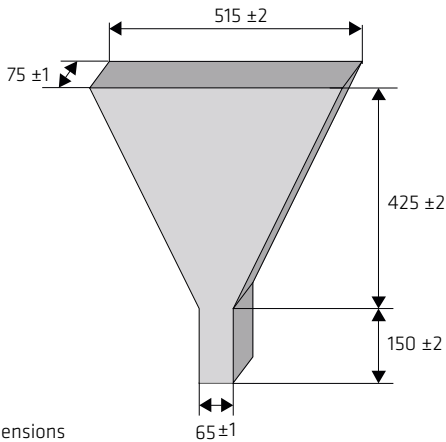

Dimensions  
in mm

Fig. 5.2.9: V-Funnel

## Testing the stability by sieve segregation test

### Principle:

This test determines the resistance of fresh self-compacting concrete against segregation. A sample of approx. 10 L has to be taken and allow the sample to stand for 15 minutes. After that waiting time the SCC is poured from a height of around 50 cm on the sieve set. Approx. 4.8 kg has to be poured on the sieve set in one operation.

### EN 12350-11

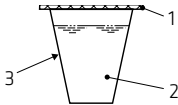
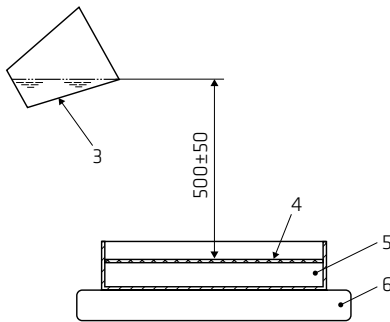

Fig. 5.2.10: Sample container and cover



- 1 Cover
- 2 Concrete
- 3 Sample container
- 4 Sieve
- 5 Sieve receiver
- 6 Balance

Fig. 5.2.11: Measurement of segregated portion

The segregated portion SR is calculated from the following equation and reported to the nearest 1%.

$$SR = \frac{(m_{ps} - m_p) * 100}{m_c} \quad [5.2.2]$$

where:

SR segregated portion [%]

$m_{ps}$  mass of sieve receiver plus passed material [g]

$m_p$  mass of the sieve receiver [g]

$m_c$  initial mass of concrete placed onto the sieve [g]



## 5.3 HOT WEATHER CONCRETE

Concreting is only possible at high temperatures if special protective measures are provided. These must be in place from the start of concrete production to the end of curing. It is dependent on the outside temperature, air humidity, wind conditions, fresh concrete temperature, heat development, dissipation and the dimensions of the element. For example the concrete should be protected from drying out during transport.

The fresh concrete must not be hotter than +30 °C during placing and installation without protective measures.

### Possible problems

With ambient temperature above 25°C non-retarded concrete can cause problems.

- Hydration is the chemical reaction of the cement and water. It begins immediately at contact, continues through stiffening to setting (initial setting) and finally to hardening of the cement paste.
- All chemical reactions are accelerated at elevated temperatures.

As a result of early stiffening placing the concrete is no longer possible.

The normal countermeasures are the use of retarded superplasticizers or superplasticizers combined with a set retarder.

### Retardation terms and dosing tables

Purpose of retardation: To extend the working time at a specific temperature.

Working time: The time after mixing during which the concrete can be correctly vibrated.

Free retardation: The initial setting is certain to start only after a specific time.

Targeted retardation: The initial setting starts at a specific time.

### Certainty comes only from specific preliminary testing!

Table 5.3.1: Decisive temperature for structural elements

Structural element and retardation	Decisive temperature
Voluminous concrete cross sections	Fresh concrete temperature
Small concrete cross sections	Air temperature at placement point

The higher temperature (fresh concrete or air temperature) is the decisive one for voluminous concrete cross sections with long retardation, and for small concrete cross sections with short retardation.

### Dosing table for concrete with free retardation

The retardation depends largely on the type of cement and mix design. Tests before application are highly recommended.

Table 5.3.2: Dosage of SikaTard® in % of cement mass (example)

Retardation time [h]	Decisive temperature					
	10 °C	15 °C	20 °C	25 °C	30 °C	35 °C
3	0.1	0.1	0.2	0.3	0.3	0.5
4	0.2	0.2	0.3	0.4	0.4	0.6
6	0.2	0.3	0.4	0.5	0.6	0.8
8	0.3	0.4	0.5	0.6	0.8	1.0
10	0.4	0.5	0.6	0.8	1.0	1.3
12	0.4	0.6	0.8	0.9	1.2	1.5
14	0.5	0.7	0.9	1.1	1.3	1.8
16	0.5	0.8	1.0	1.2	1.5	
18	0.6	0.9	1.1	1.4	1.7	
20	0.7	1.0	1.2	1.6		
24	0.8	1.1	1.5	1.8		
28	1.0	1.3	1.8			
32	1.2	1.5				
36	1.5	1.8				
40	1.8					

The dosages relate to concrete with 300 kg CEM I 42.5 N and w/c-ratio = 0.50.

The dosage should be increased by about 20% for semi-dry concrete.

The figures in this table are laboratory results and relate to one specific cement type and special formulation of retarder which might not be available everywhere.

Preliminary suitability tests are always necessary.

## Influencing factors

Various factors affect the retardation:

### Influence of temperature

- Temperature increases shorten and temperature reductions extend the retardation

### Rule of thumb

- Each degree under 20 °C extends the retardation time by about 1 hour.
- Each degree over 20 °C shortens the retardation time by 0.5 hours.

For safety: **Preliminary testing!**

### Influence of w/c-ratio

Assuming a cement content of 300 kg/m<sup>3</sup> and a SikaTard® dosage of 1%, the influence of the w/c-ratio will result in:

- An increase in the w/c-ratio of 0.01 will cause an additional retardation of about half an hour

### Combination with plasticizer / superplasticizer

- With a non-retarded superplasticizer, **SikaTard®** extends the retardation slightly.
- With a retarded superplasticizer, **SikaTard®** further extends (cumulative) the retardation.
- **Sika ViscoFlow®** can be used as a high performance workability enhancing admixture without any significant retardation of the initial setting of the concrete.

Preliminary testing should always be carried out.

### Influence of cement

The hydration process of different cements can vary due to the different raw materials and grinding fineness. The retardation effect is also susceptible to these variations, which can be considerable at dosages of over 0.8% of retarder.

The tendency:

- Pure, fine Portland cements: retardation effect reduced
- Coarser cements and some mixed cements: retardation effect extended

### For safety

- Preliminary tests!
- Always preliminary test at dosages over 0.8% of retarder!

### Influence of concrete volume

If the whole of a concrete pour is retarded, the volume has no influence on the retardation effect. During the initial set of an adjacent pour (e.g. night retardation in a deck slab), the 'decisive temperature' changes in the contact zone with the retarded next section (it increases), and this will cause the retardation effect to decrease.

## Characteristics of the retarded concrete

### ■ Hardening

If hardening starts after the retardation has stopped, it is quicker than in non-retarded concrete.

### ■ Shrinkage/creep

The final shrinkage or creep is less than in non-retarded concrete.

### ■ Early shrinkage

Contraction cracks resulting from early shrinkage can form due to dehydration during the retardation period (surface evaporation).

Protection from dehydration is extremely important for retarded concrete!

Correct curing is essential!

## Examples of concreting stages with retardation

### 1. *Night retardation*

#### ■ Foundation slabs

#### ■ Decks, beams etc.

Towards the end of the normal day's concreting, 3 strips about 1.20 m wide with increasing retardation are laid.

1<sup>st</sup> strip: 1/3 of main dosage

2<sup>nd</sup> strip: 2/3 of main dosage

3<sup>rd</sup> strip: main dosage from table or preliminary testing results

Suspension of the works overnight.

Resumption of the works next morning:

1<sup>st</sup> strip (adjacent to the 3<sup>rd</sup> from the previous day) is retarded at 1/3 of the main dosage

### 2. *Retardation with simultaneous initial setting*

This happens with large bridge decks, basement slabs etc.

Important preparations are:

#### ■ Define a precise concreting program with the engineer and contractor.

#### ■ On that basis, divide into sections and produce a time schedule.

#### ■ Target: all the sections set together.

#### ■ When the times are determined, the dosages for the individual sections can be specified on the basis of preliminary tests and precise temperature information.

## **Preliminary tests**

Preliminary tests relate only to the concrete composition specified for the retarded stage:

- Same w/c-ratio and same cement type at the same dosage

The vibration limitations should be tested on site with several concrete samples per dosage (in minimum 20 liter vessels), in temperature conditions as similar as possible to the conditions during placing.

Procedure:

- Determine the retarder dosage from the table
- Fill at least five vessels with that concrete mix
- Vibrate the contents of the first vessel two hours before the assumed initial setting
- After every further hour vibrate the next vessel (the contents of each vessel are only vibrated once)
- When the contents of a vessel cannot be vibrated anymore, the concrete has begun to set
- Note the times obtained and check whether they correspond with the predictions (in the table)
- If the differences are too big, repeat the tests with an adjusted dosage

## **Measures for retarded concrete**

### ***The formwork***

Timber formwork used for the first time can cause unsightly staining, surface dusting etc., particularly around knots, due to wood sugars on the surface.

Timber formwork which is highly absorbent, insufficiently wetted and not properly treated with release agent, draws far too much water from the concrete surface. Loose or friable particles and dusting are the result. This damage is greater in retarded concrete because the negative effects continue for longer.

Timber formwork which is properly prepared and correctly treated with **Sika® Separol®** will produce good, clean surfaces also with retarded concrete.

### ***Compaction and curing***

Retarded concrete must be compacted. The following stage (e.g. next morning) is vibrated together with the 'old pour'. Retarded areas are compacted and finished together.

Curing is enormously important, so that the retarded, compacted and now resting concrete loses as little moisture as possible.

The best methods for retarded surfaces (floors etc.) are:

- Cover with plastic sheeting or insulating blankets

On retarded areas to be vibrated again later:

- Full covering with plastic sheets or damp hessian. Protect from draughts. Additional surface watering (i.e. misting) can cause washout.

## 5.4 COLD WEATHER CONCRETE

### Set Acceleration / Cold Concrete

The concrete should be protected from rain and frost during handling.

Concreting is only permissible in freezing temperatures if special protective measures are taken. They must be in place from the start of concrete production to the end of curing.

They depend on the outside temperature, air humidity, wind conditions, fresh concrete temperature, heat development and dissipation and the dimensions of the concrete pour.

The fresh concrete must not be colder than +5 °C during placement and installation without additional protective measures. The mixing water and aggregates should be preheated if necessary.

### Challenge

Low temperatures retard the cement setting. At temperatures below -10 °C the chemical processes of the cement stops (but continues after warming). Dangerous situations arise if concrete freezes during setting, i.e. without having a certain minimum strength. Structural loosening occurs, with a corresponding loss of strength and quality. The minimum strength at which concrete can survive one freezing process without damage is the so-called freeze resistance strength of > 5 N/mm<sup>2</sup> (**Sika recommendation > 10 N/mm<sup>2</sup>**). The main objective must be to reach this freeze resistance strength as quickly as possible.

The temperature  $T_{\text{mix}}$  of fresh concrete can be calculated by the following equation:

$$T_{\text{mix}} = \frac{c * c_c * T_c + a * c_a * T_a + w * c_w * T_w + w_a * c_w * T_a}{c * c_c + a * c_a + (w + w_a) * c_w} \quad [^{\circ}\text{C}] \quad [5.4.1]$$

$c$  cement content [kg/m<sup>3</sup>]

$a$  aggregates [kg/m<sup>3</sup>]

$w$  water [kg/m<sup>3</sup>]

$w_a$  water in aggregates as surface - and core moisture [kg/m<sup>3</sup>]

$T_c$  cement temperature [°C]

$T_a$  aggregates temperature [°C]

$T_w$  water temperature [°C]

$c_c$  specific heat capacity of cement

0.72 bis 0.92 kJ/(kg·K)

$c_a$  specific heat capacity of the aggregates

Quartz 0.80 kJ/(kg·K)

Limestone 0.85 bis 0.92 kJ/(kg·K)

Granite 0.75 bis 0.85 kJ/(kg·K)

Basalt 0.71 bis 1.05 kJ/(kg·K)

$c_w$  specific heat capacity of water 4.19 kJ/(kg·K)

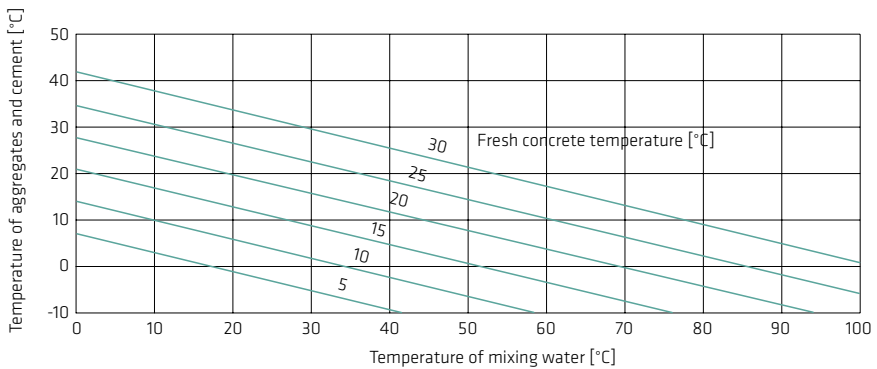

Fig. 5.4.1: Fresh concrete temperature

## Measures

### 1. Minimum temperature

According to EN 206 the fresh concrete temperature on delivery must not be below +5 °C. (For thin, fine structured elements and ambient temperatures of -3 °C or below, a fresh concrete temperature of +10 °C, which must be maintained for 3 days!) These minimum temperatures are important for setting to take place at all. The concrete should be protected from heat loss during handling and after placing.

### 2. Reduction of w/c-ratio

The lowest possible water content leads to a rapid increase in initial strength. In addition, there is also less moisture available which could freeze. Superplasticizers allow a low w/c-ratio while retaining good workability.

### 3. Hardening acceleration

The use of SikaRapid® gives maximum hardening acceleration when there are high initial strength requirements.

Table 5.4.1: Time to reach 10 N/mm<sup>2</sup> at 0 °C in days (example)

Concrete	Time in days	
	Control mix [d]	With 1% SikaRapid® [d]
CEM I 300 kg/m <sup>3</sup> w/c = 0.40	4 d	1 d
CEM I 300 kg/m <sup>3</sup> w/c = 0.50	8 d	2 d

#### 4. Use of CEM I 52.5

The more finely ground, top grade cements are known to produce a more rapid increase in initial strength. Superplasticizers guarantee the best workability with a low w/c-ratio.

##### Protective measures on site

1. No concreting against or on frozen existing concrete.
2. The steel reinforcement temperature must be more than 0 °C.
3. Install the concrete quickly and immediately protect it from heat loss and evaporation (as important as in summer!). Thermal insulation blankets are best for this.
4. For slabs: Heat the formwork from below if necessary.
5. Check air/ambient and concrete temperatures and the strength development regularly (e.g. with a rebound hammer).
6. Extend the formwork dismantling and striking times!

##### Example

Outside temperature of -5 °C and a fresh concrete temperature of 11 °C.

Structural element	Decrease of concrete temperature down to +5 °C within	
Concrete deck d = 12 cm on timber formwork	~ 4 hours <b>without</b> insulation blankets	~ 16 hours <b>with</b> insulation blankets

Conclusion:

Winter measures must be planned and organized at an early stage by all parties.



## 5.5 FRESH CONCRETE AIR CONTENT

### Determination of Air Content

There are two test methods using equipment operating on the same principle (Boyle-Mariotte's Law): these are the water column method and the pressure equalization method. The description below is for the pressure equalization method, as this is more commonly used.

#### **Principle:**

**A known volume of air at a known pressure is equalized with the unknown volume of air in the concrete sample in a tightly sealed chamber. The scale graduation of the pressure gauge for the resultant pressure is calibrated to the percentage of air content in the concrete sample.**

#### **EN 12350-7**

- 1 Pump
- 2 Valve B
- 3 Valve A
- 4 Expansion tubes for checks during calibration
- 5 Main air valve
- 6 Pressure gauge
- 7 Air outlet valve
- 8 Air chamber
- 9 Clamp seal
- 10 Container

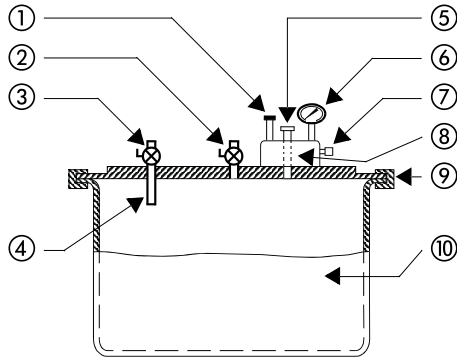

Air void test containers for standard concrete normally have a capacity of 8 liters. Compaction can be carried out with a poker or table vibrator. If using poker vibrators, ensure that entrained air is not expelled by excessive vibration.

Neither method is suitable for concrete produced with lightweight aggregates, air-cooled blast furnace slags or highly porous aggregates.

## 5.6 FRESH CONCRETE DENSITY

### Determination of Fresh Concrete Density

**Principle:**

***The fresh concrete is compacted in a rigid, watertight container and then weighed.***

#### EN 12350-6

The minimum dimensions of the container must be at least four times the maximum nominal size of the coarse aggregate in the concrete, but must not be less than 150 mm. The capacity of the container must be at least 5 liters. The top edge and base must be parallel.

(Air void test pots with a capacity of 8 liters have also proved very suitable.)

The concrete is compacted mechanically with a poker or table vibrator or manually with a bar or tamper.

$$\rho = \frac{m_t - m_{\text{Pot}}}{V_{\text{Pot}}} * 1'000 \quad [\text{kg/m}^3] \quad [5.6.1]$$

where:

- $\rho$  density [kg/m<sup>3</sup>]
- $m_t$  total weight [kg]
- $m_{\text{Pot}}$  weight air void test pot [kg]
- $V_{\text{Pot}}$  volume air void test pot [L]

## 5.7 FRESH CONCRETE TEMPERATURE

The fresh concrete temperature should not be too low, so that the concrete gains sufficient strength fast enough and does not suffer damage from frost at an early age.



- The fresh concrete temperature should not drop below +5 °C during placement and installation.
- The freshly placed concrete should be protected from frost. Freezing resistance is reached at a compressive strength of approximately 10 N/mm<sup>2</sup> (Sika recommendation).
- On the other hand, too high concrete temperatures can result in (cause) placement problems and decline of certain hardened concrete properties. To avoid this, the fresh concrete temperature should not go above 30 °C during placement and installation.

### **Precautions at low temperatures**

→ see cold weather concrete in cold ambient temperature conditions, see Chapter 5.4

### **Precautions at high temperatures**

→ see hot weather concrete in warm temperature ambient conditions, see Chapter 5.3

## 5.8 COHESION AND BLEEDING

The homogeneity and the internal cohesion of the concrete are the determining factors for an easy to handle and durable concrete. If the internal cohesion is bad and / or the homogeneity is insufficient, separation, bleeding and structure disturbances can occur and the structure of the concrete is damaged.

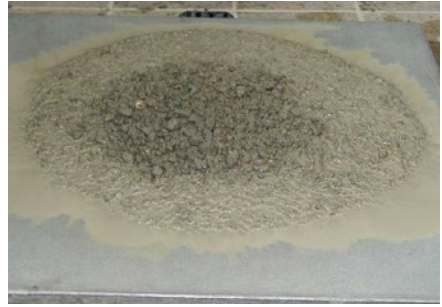

### COHESION

How to improve cohesion / homogeneity?

- Check the mix design concerning cement paste and fines content
  - Adapt the grading curve of the aggregates
  - Increase the fines (powder + fine sand)
- Target low w/c-ratios with simultaneous soft / fluid consistence  
→ **Sika® ViscoCrete®** technology
- Use a water retaining /viscosity modifying admixture (VMA)  
→ **Sika® Stabilizer Pump / Sika® Stabilizer VMA**
- Use an air-entrainer → **SikaControl® AER**

Insufficient internal cohesion and / or homogeneity lead to

- Separation of the concrete
- Segregation of the concrete
- Structure disturbances can occur and the structure of the concrete is damaged
- Hindered concrete placing

## BLEEDING

Bleeding is the leakage of water on the surface caused by separation of the concrete. It often occurs as a result of the lack of fines in the aggregate and in low cement or high water containing mixes.

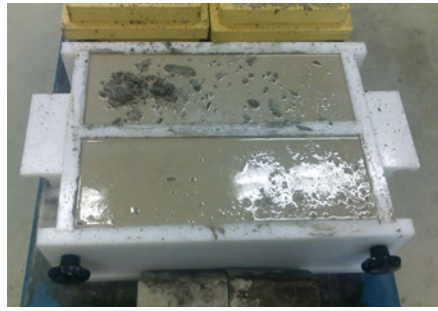

### Causes for bleeding

- Lack of fines in the aggregates
- Low cement containing mixes
- High water containing mixes
- Low fines containing mixes
- Variations in raw material dosage due to improper batching
- Overdosing of superplasticizer

### Consequences

- Irregular, dusting, porous concrete surface
- Inadequate resistance to environmental actions and mechanical wear of concrete surface
- Efflorescence on the concrete surface

### Possibility to reduce bleeding

- Optimize grading curve
- Reduce water content
- Use a viscosity modifying admixture (VMA)
- Increase the binder content



# 6 CONCRETE APPLICATION

## 6.1 CRANE AND BUCKET CONCRETE

Crane and bucket concrete is a site- or ready-mixed concrete, which is conveyed to the actual application place by means of special buckets and crane transport. The concrete is poured into the formwork through an outlet at the bottom of the bucket.

This application method is widely used and does not require a special concrete mix design. In fact almost all concrete types can be installed with this method as soon as the concrete is characterized by a minimum consistence.



The versatility of this application method and the fact that no special concrete mix design is required are the major advantages. As a result crane and bucket concrete applications are very economic on the one hand. On the other hand it is an easy concrete installation, because as soon as a crane is present on the construction site, the contractor can place any kind of concrete with the bucket.

This means almost any kind of concrete can be installed, like

- Low flowability to self-compacting concrete
- Low strength to high strength concrete
- Any kind of concrete regarding exposure class and durability requirements

Moreover this concrete installation method has no influence on fresh and hardened concrete properties like air void content or final strength.

The method of placing concrete by crane and bucket has limitations regarding the amount of concrete which can be applied in a certain period of time. If larger amounts of concrete has to be installed this method is unfavorable.

Due to the fact that almost all concrete types regarding fresh and hardened concrete characteristics can be placed by crane and bucket, there is a large variety of Sika concrete admixtures that can be applied.

During the placing of crane and bucket concrete great falling heights have to be avoided, especially in case of fair-faced concrete, highly flowable concrete and self-compacting concrete. Great falling heights can result in segregation of the fresh concrete, which should be mitigated by the use of installation hoses.





## 6.2 PUMPED CONCRETE

The pumping of concrete is a highly efficient method of quickly conveying particularly large quantities of concrete. This method essentially requires a suitable mix design so that the concrete can be pumped without segregation and clogging of the pipes.

Pumped concrete offers the advantage of high concrete installation rates and great construction site flexibility.



### Composition

#### ■ Aggregate

- Max. particle diameter < 1/3 of pipe diameter
- The fine mortar in the pumped mix must have good cohesion to prevent concrete segregation during the pumping process

Table 6.2.1: Standard values for fines content (content of material < 0.125 mm) according to SN EN 206

Max. aggregate size	8 mm	16 mm	32 mm
Fines content	450 kg/m <sup>3</sup>	400 kg/m <sup>3</sup>	350 kg/m <sup>3</sup>

Table 6.2.2: Sika recommendation for fines content

Max. aggregate size	Round aggregates	Crushed aggregates
8 mm	500 kg/m <sup>3</sup>	525 kg/m <sup>3</sup>
16 mm	425 kg/m <sup>3</sup>	450 kg/m <sup>3</sup>
32 mm	375 kg/m <sup>3</sup>	400 kg/m <sup>3</sup>

Grading curve: Pumped concrete should be composed of different individual sand and aggregate fractions, if possible. A continuously graded particle-size distribution curve is important.

The 4 – 8 mm content should be kept low, but there should be no discontinuous gradation.

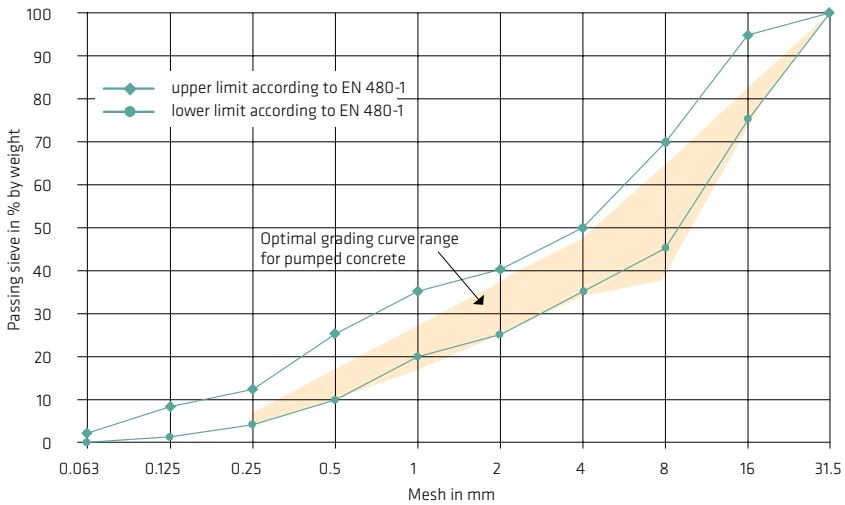

Fig. 6.2.1: Optimal grading curve range for pumping concrete

## ■ Cement

Table 6.2.3: Sika recommendation for cement content

Max. aggregate size	Round aggregates	Crushed aggregates
8 mm	380 kg/m <sup>3</sup>	420 kg/m <sup>3</sup>
16 mm	330 kg/m <sup>3</sup>	360 kg/m <sup>3</sup>
32 mm	300 kg/m <sup>3</sup>	330 kg/m <sup>3</sup>

## ■ Water / binder-ratio (w/b-ratio)

If the water content is too high, segregation and bleeding occurs during pumping and this can lead to blockages. The water content should always be reduced by using superplasticizers.

## Workability

The fresh concrete should have a soft consistence with good cohesion. Ideally the pumped concrete consistence should be determined by the degree of compactability or flow table test.

## ■ Fresh concrete consistence

Test method	Consistence class	Measurement
Degree of compactability	C2 - C3	1.04 - 1.25
Flow table spread	F3 - F4	42 - 55 cm

## ***Pumping agents***

Unfavorable aggregates, variable raw materials, long delivery distances or high volume installation rates require utilization of a pumping agent. This reduces friction and resistance in the pipe, reduces the wear on the pump and the pipes and increases the volume output.

## ■ Pump lines

- Diameter of 80 to 200 mm (commonly used diameter 100 and 125 mm)
- The smaller the diameter, the more complex the pumping (surface / cross-section)
- The couplings must fit tightly to prevent loss of pressure and paste
- The first few meters should be as horizontal as possible and without bends particularly important ahead of risers
- Protect the lines from strong sunshine in summer

## ■ Lubricant mixes

The lubricant mix is intended to coat the internal walls of the pipe with a fines layer to allow easy pumping from the start.

- Conventional mix: Mortar 0 - 4 mm, cement content as for the following concrete quality or slightly higher
- Quantity dependent on diameter and line length
- Lubricant mix produced with **SikaPump® Start-1**

## ■ Effect of air content on concrete

Frost and freeze / thaw resistance concrete containing micropores can be pumped if the air content remains < 5%, as with higher air content increased resilience can be generated.

## Sika product use

Product name	Product type	Product use
<b>Sika® ViscoCrete®</b> <b>SikaPlast®</b> <b>Sikament®</b>	Superplasticizer	Water reduction, increased strength and impermeability with guaranteed consistency (workability) and pumpability
<b>Sika ViscoFlow®</b>	Workability enhancing admixture	Extended workability time, water reduction
<b>SikaFume®</b>	Silica fume	High strength, increased impermeability, improved pumpability
<b>Sika® Stabilizer Pump</b>	Pumping agent	Supports the pumping with unfavorable aggregates and protects the equipment from excessive wear
<b>Sika® Stabilizer VMA</b>	Viscosity modifying agent	Maintains internal cohesion. Supports the pumping with difficult aggregates and protects the equipment from excessive wear
<b>SikaPump® Start-1</b>	Lubricant agent	Production of lubricant mix for lubrication of the pipe walls; facilitates problem free pumping of cementitious mixes

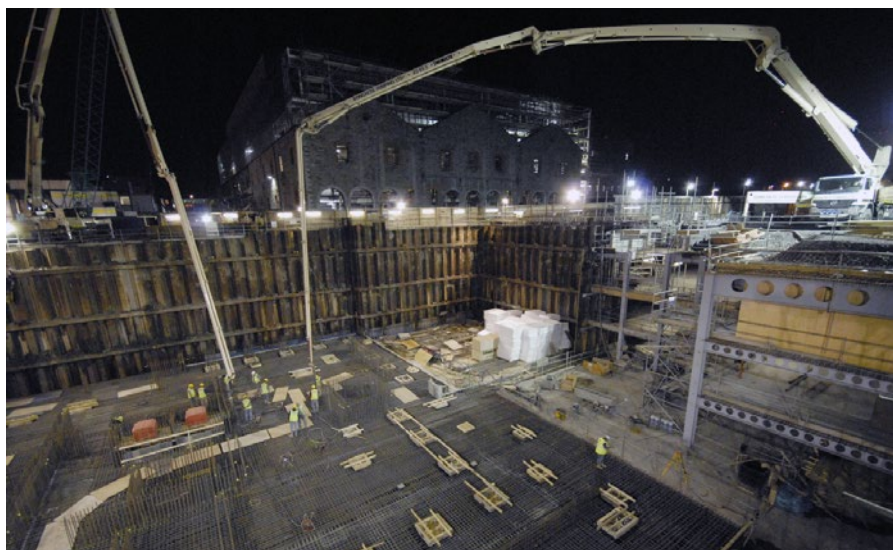

## 6.3 SELF-COMPACTING CONCRETE (SCC)

Self-compacting concrete (SCC) is an innovative concrete that does not require vibration for placing and compaction. It is able to flow under its own weight, completely filling formwork and achieving full compaction, even in the presence of congested reinforcement. The hardened concrete is dense, homogeneous and has the same engineering properties and durability as traditionally vibrated concrete.



Self-compacting concrete (SCC) has higher fines content than conventional concrete due to higher binder content and a different combined aggregate grading curve. These adjustments, combined with specially adapted superplasticizers, produce unique fluidity and inherent compactability.

Self-compacting concrete opens up new potentials beyond conventional concrete applications:

- Use with closely meshed reinforcement
- For complex geometric shapes
- For slender components
- Generally where compaction of concrete is difficult
- For specifications requiring a homogeneous concrete structure
- For fast installation rates
- To reduce noise (eliminate or reduce vibration)
- To reduce damage to health ('white knuckle' syndrome)

## Composition

### ■ Aggregate

Smaller maximum particle sizes of approx. 12 to 20 mm are preferable, but all aggregates are possible in principle.

#### Example of aggregate grading

Particle size fraction	SCC 0/8 mm	SCC 0/16 mm	SCC 0/32 mm
0/4 mm	60%	53%	45%
4/8 mm	40%	15%	15%
8/16 mm	-	32%	15%
16/32 mm	-	-	25%

#### Fines content $\leq 0.125$ mm (cement, additives and fines)

SCC 0/4 mm	$\geq 650$ kg/m <sup>3</sup>
SCC 0/8 mm	$\geq 550$ kg/m <sup>3</sup>
SCC 0/16 mm	$\geq 500$ kg/m <sup>3</sup>
SCC 0/32 mm	$\geq 475$ kg/m <sup>3</sup>



### ■ Binder content

Based on the fines content, the following binder contents can be determined, depending on the concrete quality required and the max. aggregate diameter used:

Cement and additives (total)	
SCC 0/4 mm	550 – 600 kg/m <sup>3</sup>
SCC 0/8 mm	450 – 500 kg/m <sup>3</sup>
SCC 0/16 mm	400 – 450 kg/m <sup>3</sup>
SCC 0/32 mm	375 – 425 kg/m <sup>3</sup>

### ■ Water content

The water content in SCC depends on the concrete quality requirements and can be defined as follows:

Cement and additives (total)	
≥ 200 L/m <sup>3</sup>	Low concrete quality
180 to 200 L/m <sup>3</sup>	Standard concrete quality
≤ 180 L/m <sup>3</sup>	High concrete quality

### ■ Concrete admixtures

To ensure the fresh concrete properties of self-compacting concrete the application of a powerful superplasticizer based on polycarboxylate-ether (PCE), like **Sika® ViscoCrete®** technology, is mandatory. By doing so the water content can be kept low and homogeneity as well as viscosity can be adjusted.

## Installation of SCC

### ■ Formwork surface

The formwork for SCC must be clean and tight. The formwork pressures can be higher than for normal vibrated concrete. The formwork pressure is dependent on the viscosity of the concrete, the installation rate and the filling point. The full hydrostatic pressure potential of the concrete should be used for the general formwork design.

### ■ Placing method

Self-compacting concrete is placed in the same way as conventional concrete. SCC must not be freely discharged from a great height. The optimum flow potential and surface appearance are obtained by installation with a filling socket from below or by tremie pipes which reach beneath the concrete surface level.

### Sika product use

Product name	Product type	Product use
<b>Sika® ViscoCrete®</b>	Superplasticizer	Increased strength and impermeability High water reduction Enhances self-compacting properties
<b>Sika ViscoFlow®</b>	Workability enhancing admixture	Extended workability time, water reduction
<b>SikaFume®</b>	Silica fume	High strength, increased impermeability Supports the stability of the entrained air
<b>Sika® Stabilizer Pump</b>	Pumping agent	Supports the pumping with unfavorable aggregates and protects the equipment from excessive wear
<b>Sika® Stabilizer VMA</b>	Viscosity modifying agent (VMA)	Boosts cohesion Fines substitute





## 6.4 CONCRETE FOR TRAFFIC AREAS

Concrete for traffic areas has many applications and is often installed as an alternative to blacktop because of its durability and other advantages.

The uses of concrete for traffic areas:

- Conventional road building
- Concrete roundabouts
- Runways / taxiways
- Parking areas



If concrete is used for these applications, the concrete layer acts as both a load bearing and a wearing course. To meet the requirements for both courses, the concrete must have the following properties:

- High flexural strength
- Freeze/thaw resistance, depending on climate and expected exposure
- Good skid resistance
- Low abrasion

The composition is a vital factor in achieving the desired requirements. The criteria for selection of the various constituents are as follows:

### ■ Aggregate

- Use of low fines mixes
- Use of a balanced particle size distribution curve
- Crushed or partly crushed aggregate increases the skid resistance and flexural strength

### ■ Cement

- Dosage 300 – 350 kg/m<sup>3</sup>, usually Portland cement

### ■ Additives

- Silica fume for heavily impacted areas or to generally increase the durability
- Increased skid resistance by spreading silicon carbide or chippings into the surface

Concrete for traffic areas is a special concrete and the following points require special attention:

- Large areas are often installed using road pavers
- The consistence must be suitable for the type of machine
- Improvement in skid resistance by cut grooves or brush finishing
- Thorough curing is essential

To ensure the required skid resistance and roughness a system approach is suitable by applying a surface retarder / curing agent. In case of road construction this is usually executed by a special trailer and subsequent brushing out of the surface at a specific time after concrete installation.

### Sika product use

Product name	Product type	Product use
<b>Sika® ViscoCrete®</b> <b>SikaPlast®</b> <b>Sikament®</b>	Superplasticizer	Water reduction, improved compressive and flexural strength, improved consistence
<b>SikaFume®</b>	Silica fume	High strength, increased impermeability
<b>SikaControl® AER</b>	Air-entrainer	Air-entrainment to increase freeze / thaw resistance
<b>SikaRapid®</b>	Hardening accelerator	Control of the hardening process of concrete
<b>SikaTard®</b>	Set retarder	Control of the setting process
<b>Sika® Antisol®</b>	Curing agent	Protection from premature drying
<b>Sika® Rugasol®</b>	Curing agent / surface retarder	Protection from premature drying and surface retardation to ensure easy surface brushing out



## 6.5 MASS CONCRETE

Mass concrete refers to very thick structures (> 80 cm). These structures have a large volume, which generally means that large volumes of concrete have to be installed in a short time. This requires extremely good planning and efficient processes.

### Mass concrete is used for:

- Foundations for large loads
- Foundations for buoyancy control
- Massive walls (e.g. radiation protection)



### These massive structures create the following main problems:

- High temperature differences between internal and external concrete layers during setting and hardening
- Very high maximum concrete temperatures
- As a result of curing from the outside to the inside, big differences in the humidity occur and therefore shrinkage is forced
- Secondary consolidation (settling) of the concrete and therefore cracking over the top reinforcement layers and also settlement under the reinforcement bars

### Risks:

All these problems can cause cracks and cement matrix defects:

So-called 'skin or surface cracks' can occur if the external/internal temperature difference is more than 15 °C or the outer layers can contract due to their drying out. Skin cracks are generally only a few centimeters deep and can close again later.

### Measures to be taken:

- Low cement content and cements with low heat development
- Largest possible maximum aggregate size (e.g. 0 - 50 mm instead of 0 - 32 mm)
- If necessary, cool aggregates to obtain a lower initial fresh concrete temperature
- Place the concrete in layers (layer thickness < 80 cm)
- Retard the bottom layers to ensure that the whole section can be recompact after placing the top layer
- Use curing with thermal insulation methods
- Ensure correct design and distribution of joints and concreting sections, to facilitate heat dissipation and accommodate temperature fluctuations

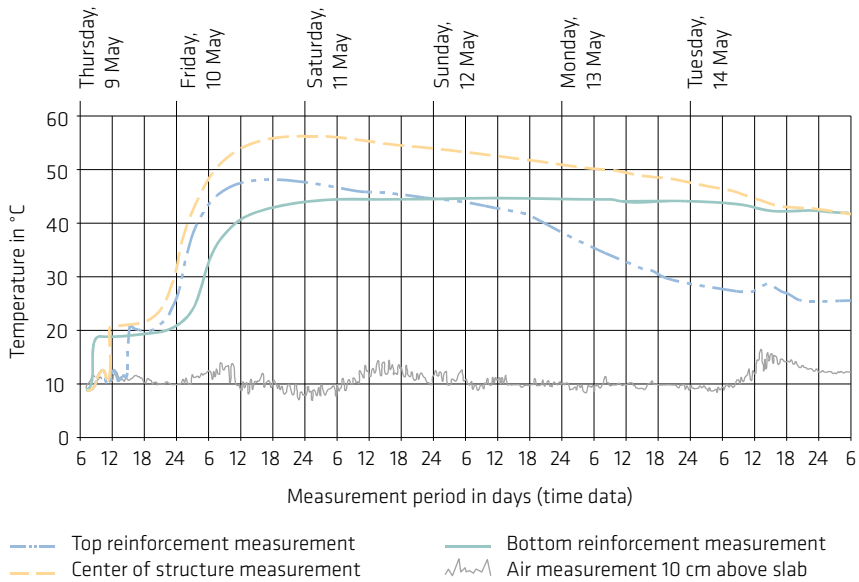

Fig. 6.5.1: Measurement of hydration heat in a 160 cm thick ground slab placed in three levels

## Sika product use

Product name	Product type	Product use
Sika® ViscoCrete® SikaPlast® Sikament®	Superplasticizer	Substantial water reduction, ensured workability and pumpability
SikaTard®	Set retarder	Control of the setting process
Sika® Antisol®	Curing agent	Protection from premature drying

## 6.6 MONOLITHIC CONCRETE FOR INDUSTRIAL FLOORS

Monolithic concrete is utilized for the construction of tear resistant and plain concrete floors or decks. These concrete floors are characterized by high quality, durability and economy.

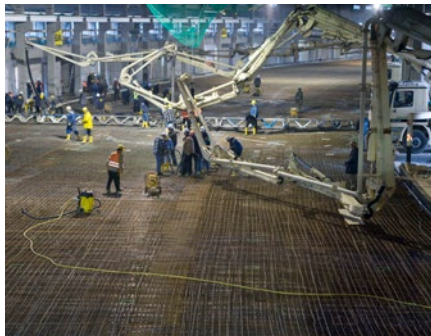

### Composition

Depending on the special requirements the concrete mix must be adapted (abrasion resistance concrete, frost resistant concrete etc.).

### Placing

Placing is done by standard placing and compaction with immersion vibrators. Smooth off with vibrating beam. After the stiffening process begins, the surface is finished with power floats.

### Curing

Curing has to start as early as possible and should be maintained for sufficient period of time, by spraying **Sika® Antisol** (Attention! Take any subsequent coating into consideration!) or by covering with sheets.

### Notes

- Check the potential for the use of fibers when forming monolithic concrete slabs.
- To improve the finished surface, we recommend the use of **Sikafloor® Top Dry Shakes**, which are sprinkled onto the surface during the finishing operation.
- Suitable superplasticizer selection is of high importance. Workability time and setting of the concrete have to match to construction site requirements because of timing of the finishing with power floats. Perform suitability tests in advance, especially with superplasticizers offering extended slump life.

## Sika recommendation:

### Aggregates

- Crushed or round aggregates suitable but preferable round aggregates
- Maximum grain size 16 mm for pumped concrete
- 4 to 8 mm fraction should kept low
- Sand fraction (0 to 4 mm) amount over 40%

### Cement and fines

- Minimum cement content according to EN 206; approx. 330 to 360 kg/m<sup>3</sup> cement content
- CEM I or CEM II cements are recommended
- Minimum amount of fines around 425 to 450 kg/m<sup>3</sup>

### Water

- w/c-ratio shall be below 0.55
- Use hot water in the mix in winter time (max. 50 °C)
- No extra water addition on the job site

### Admixtures

- Suitable PCE based superplasticizer should be selected in close cooperation with the admixture supplier

## Sika product use

Product name	Product type	Product use
<b>Sika® ViscoCrete®</b> <b>SikaPlast®</b> <b>Sikament®</b>	Superplasticizer	Increased strength and impermeability Good workability Good green strengt
<b>SikaRapid®</b>	Accelerator	Control of the hardening / setting process at low temperatures
<b>Sikafloor®</b> <b>Top Dry Shakes</b>	Mineral, synthetic and metallic types	Improved abrasion Option of coloring
<b>Sikafloor® ProSeal</b>	Curing and hardening surface sealer	Reduced water loss Supports hardening and curing, seals the surface
<b>Sika® Stabilizer Pump</b>	Pumping agent	Supports the pumping with unfavorable aggregates and protects the equipment from excessive wear
<b>SikaFiber®</b>	Micro / macro fibers	Improves shrinkage reduction
<b>Sika® Antisol®</b>	Curing agent	Reduced water loss

## 6.7 ROLLER-COMPACTED CONCRETE (RCC)

Roller-compacted concrete (RCC) is composed of the same components as conventional concrete (cement, admixtures, sand, gravel, water and mineral additives) but it is transported, placed and compacted with earth-moving machines.

Roller-compacted concrete is used for construction of dams, large surfaces (parking areas) and road stabilization, whereas dam construction is the major application field.



### Technology

One of the major characteristics of RCC is its semi-dry appearance, which can be described as a 'no slump concrete' consistence. This results from the low cement and water content of this concrete type. RCC mixes for dams with lowest cement content have between 60 and 100 kg/m<sup>3</sup> of cementitious material; RCC with high cementitious material content can have up to 220 kg/m<sup>3</sup>.

With regard to aggregates RCC mixes can have maximum aggregate diameters of up to 120 mm on the one hand. On the other hand this special concrete type has higher fines content of more than 10% of the dry weight of the aggregates.

### Strength and Density

In most of the cases roller-compacted concrete does not develop higher compressive strength with a lowered w/b-ratio. Driving factor for strength development is the compactability of the material, as it has to be compacted with heavy machines in a vibro-compaction process. As a consequence there is an optimum moisture content which allows for reaching higher density and with this higher strength values.

### RCC Mix Design

When designing roller-compacted concrete compressive strength is not of major interest: it is the shear or direct tensile strength that controls the design. In general terms the mix design focus is as follows:

- Approach to specific granulometric curves, minimizing the required amount of cementitious material
- Determination of the optimum moisture content through maximum density tests
- Guarantee the minimum paste volume content

### Bonding of the different layers

Roller-compacted concrete is placed in layers (usually 15 – 45 cm) and compacted with vibro-compactors (4 – 8 passes) leading to special considerations regarding sufficient bonding between these layers. There are two methods executed:

**Hot joint method** – the subsequent layer is placed and compacted before the previous layer has reached its setting point. With this method the setting point of the concrete has to be evaluated in tests. It is the most economic, fastest method allowing high placing rates.

**Cold joint method** – to be used when construction circumstances do not allow the hot joint method. The concrete surface has to be pre-treated to increase the bond. Afterwards a bonding mortar or concrete layer with a high flowability is installed and followed by this the next RCC layer can be placed.

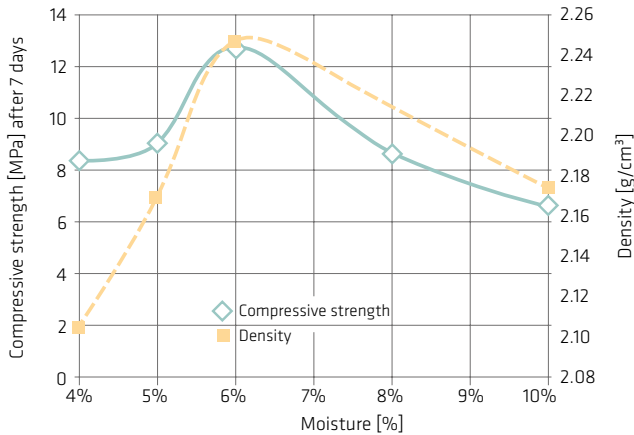
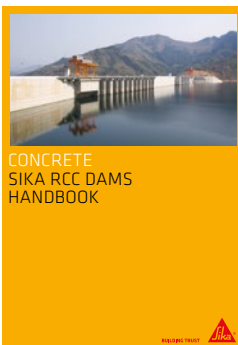

Fig. 6.71: Laboratory results (Stancy Dam)

### Sika product use

Product name	Product type	Product use
Sika® ViscoCrete® SikaPlast® Sikament®	Superplasticizer	Improved compactability and durability, ensured workability over time
SikaControl® AER	Air-entrainer	Secured frost and freeze / thaw resistance



**Please refer to the 'Sika RCC Dams Handbook' for detailed information.**



## 6.8 SLIPFORM CONCRETE

With slipform technology, the formwork is moved continuously in sync with the concreting process in a 24-hour operation. Concreting the formwork, including the working platform and the hanging scaffold mounted internally or on both sides, is fixed to the jacking rods in the center of the wall. The hydraulic oil operated lifting jack raises the formwork by 15 to 30 cm per hour depending on the temperature.



The jacking rods are located in pipe sleeves at the top and are supported by the concrete that has already hardened. The rods and sleeves are also raised continuously. These works are carried out almost entirely by specialist contractors.

Slipforming is quick and efficient. The method is particularly suitable for simple, consistent ground plans and high structures such as:

- High bay warehouses, silos
- Tower and chimney structures
- Shaft structures

Because the height of the formwork is usually only around 1.20 m and the hourly production rate is 15 to 30 cm, the concrete underneath is 4 to 8 hours old and must be stiff enough to bear its own weight (green strength). However, it must not have set enough for some of it to stick to the rising formwork ('plucking'). The main requirement for slipforming without problems is concreting all areas at the same level at the same time and then the simultaneous setting of these layers. Therefore the temperature has a major influence, along with the requirement for the consistently optimum w/c-ratio.

Note in particular that a wall thickness of less than 15 cm can be a problem (plucking, anchorage of jacking rods etc.). The newly struck surfaces should be protected as much as possible from wind, sunlight etc..

## Sika recommendations

### ■ Aggregate

- 0 - 32 mm or 0 - 16 mm for close reinforcement
- Although slipform concrete is mainly crane handled concrete, the fines content should be as for pumped concrete

### ■ Cement

- Minimum 300 kg/m<sup>3</sup>
- CEM I 42.5 for close reinforcement and large dimensions, CEM I 52.5 for smaller dimensions (towers, chimneys)

### ■ Workability

The best workability has proved to be a stiff plastic concrete having a flow table spread of 35 - 40 cm and a low water content.

## Sika product use

Product name	Product type	Product use
<b>Sika® ViscoCrete®</b> <b>SikaPlast®</b> <b>Sikament®</b>	Superplasticizer	Increased strength and impermeability Substantial water reduction Good initial strength development
<b>SikaFume®</b>	Silica fume	High strength, increased impermeability Fines enrichment
<b>Sika® Stabilizer VMA</b>	Viscosity modifying agent	Boosts cohesion Fines replacement
<b>SikaControl® AER</b>	Air-entrainer	Introduction of air voids Production of frost and freeze / thaw resistant slipform concrete
<b>SikaRapid®</b>	Accelerator	Control of the hardening / setting processes of slipform concrete
<b>SikaTard®</b>	Set retarder	Control of the setting processes of slipform concrete
<b>Sika® Separol®</b>	Mold release agent	Contribute to a visually uniform and durable concrete surfaces

## 6.9 SPRAYED CONCRETE

Sprayed concrete is a construction material which results from the combination of materials (concrete, admixtures) and a specific application method (spraying).

The base mix, either dry or wet, is delivered to a nozzle where it is sprayed with compressed air to the substrate. During this spraying process, the final wet mix is achieved, an accelerator can be added and the sprayed concrete is, finally, compacted.



Sprayed concrete has a wide application range due to its high flexibility, good economics and good physical properties. However, the sprayed concrete method is requiring a high degree of mechanization and well trained nozzle operators. Nevertheless, the advantage over conventional concreting methods is outstanding: the application of concrete without any formwork and even overhead.

Sprayed concrete is mainly used in the following applications:

### Uses

- Excavation stabilization in tunneling and mining
- Trench and slope stabilization
- High performance linings
- Repair and refurbishment works

### Requirements for sprayed concrete

- Adjusted workability (open time)
- Good pumpability
- Low rebound and dust formation
- Good adhesion to substrate
- Fast stiffening and early-strength evolution
- High durability

## Strength Classes (EN 14487-1)

The major part of sprayed concrete is applied in underground construction. Particularly, the early strength development plays a central role. Sprayed concrete should be applied quickly in thick layers, including overhead. According to the intended use, the strengths of freshly-applied sprayed concrete is divided into three classes: J1, J2 and J3 (EN 14487).

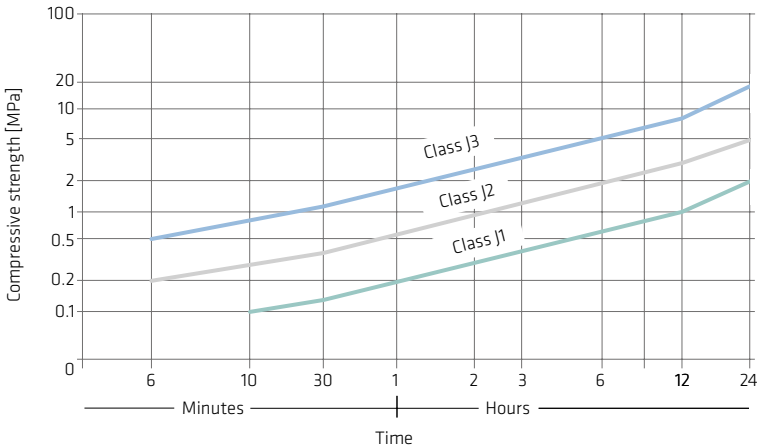

Fig. 6.9.1: Sprayed concrete early strength classes according to EN 14487-1

**Class J1** sprayed concrete is appropriate for application in thin layers on a dry substrate. No structural requirements are to be expected in this type of sprayed concrete during the first hours after application. Typically, J1 shotcrete is used in slope and trench stabilization.

**Class J2** sprayed concrete is used in applications where thicker layers have to be achieved within short time. This type of sprayed concrete can be applied overhead and is suitable even at difficult circumstances, e.g. immediate excavation stabilization.

**Class J3** sprayed concrete is used in case of highly fragile rock or water afflux. Due to its rapid setting, more dust and rebound occurs during the application and therefore, class J3 sprayed concrete is only used in special cases.

## THE SPRAYING PROCESS

### Wet spray process

There are two different wet spraying processes, namely thin-flow and dense-flow. In the **dense-flow** process, the base concrete is pumped in a dense stream to the nozzle with a concrete pump. At the nozzle the pumped base mix is dispersed by compressed air, thus, changed to a thin stream. The accelerator which is added into the compressed air just ahead of the nozzle, is homogenously mixed with the base mix at the same time.

The same base mix can be delivered through a rotor machine by **thin-flow** conveying. The material is transported pneumatically by compressed air, as it is performed in dry spraying shotcrete (gunite). The accelerator is added at the nozzle with additional compressed air. Assuming that the same requirements are specified for the applied sprayed concrete, both processes – dense- and thin-flow application – require the same base mix in terms of granulometry, w/c-ratio, admixtures, additives and cement content. In order to reduce the rebound, the grain size is usually limited to 8 mm. However, the fines content in the wet thin-flow should be somewhat lower in order to avoid clogging by deposited fines in the hoses.

### Example of mix design for 1 m<sup>3</sup> wet sprayed concrete

Wet sprayed concrete 0 – 8 mm, sprayed concrete class C 30/37, CEM I 42.5

Components	Content	Volume
Cement	400 kg/m <sup>3</sup>	127 L
Aggregates: 60% Sand 0 – 4 mm (dry)	1'031 kg/m <sup>3</sup>	385 L
Aggregates: 40% Gravel 4 – 8 mm (dry)	687 kg/m <sup>3</sup>	256 L
Mixing water (w/c = 0.48) (including water content aggregates)	192 kg/m <sup>3</sup>	192 L
Air voids (4.0%) 1% $\cong$ 10 L in 1 m <sup>3</sup>		40 L
<b>Sprayed concrete</b>		<b>1'000 L</b>
<b>Unit weight per m<sup>3</sup></b>	<b>2'310 kg</b>	

### Admixtures

Water reducer:

**Sika® ViscoCrete® SC**, dosage 1.0%

Alkali-free accelerator:

**Sigunit® AFL**, dosage 5 – 9%

**1 m<sup>3</sup> applied wet sprayed concrete results in 0.90 – 0.94 m<sup>3</sup> solid material on the wall.**

## PRODUCTS FOR SPRAYED CONCRETE

### **Sika® ViscoCrete® SC – superplasticizer for sprayed concrete**

Superplasticizers for sprayed concrete differ from traditional plasticizers/superplasticizers.

They are subject to the following additional requirements:

- Good pumpability with low w/c-ratio
- Extended workability time/slump life
- Compatibility with the selected accelerator to support the strength development

### **Sika® Sigunit® – sprayed concrete accelerator**

**Sika® Sigunit®** causes a rapid setting of the sprayed concrete and accelerates the strength development in the first hours.

**Sika® Sigunit® AFL** alkali-free accelerator

**Sika® Sigunit® L** alkaline accelerator

### **SikaFume® – silica fume**

The SiO<sub>2</sub> in silica fume reacts with calcium hydroxide to form additional calcium silicate hydrate. This makes the cement matrix denser, harder and more resistant. Today's requirements for sprayed concrete, such as watertightness and sulfate resistance, are not easily met without the addition of silica fume.

### **SikaTard® – set retarding admixture**

**SikaTard®** regulates the hydration of sprayed concrete. This enables nearly arbitrary extension of sprayed concrete's workability, so that freshly mixed sprayed concrete can be worked without difficulty throughout periods of time defined by the user from just a few hours to up to 72 hours.

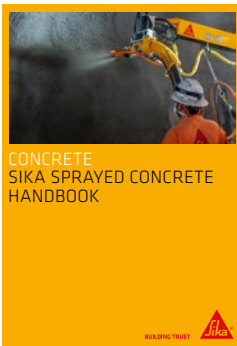

**Please refer to the 'Sika Sprayed Concrete Handbook' for detailed information.**

## 6.10 WET PRECAST CONCRETE

Precast concrete is used to build structures which are delivered after hardening. Concrete used for the production of precast structures requires an industrialized production process, and a good concrete mix design with continuous optimization is essential.



The following production steps are connected to different technical challenges within the precast production and final erection of finished elements:

- Build up and preparation of reinforcement
- Preparation of formwork – tight formwork and correct application of suitable mold release agent
- Concrete production – cost efficient mix design that complies to standards and fulfils technical requirements
- Transport and installation of fresh concrete – sufficient slump life and high flowability for fast installation
- Finishing of the concrete surface – no time delay within production and improved finishing characteristics
- Curing of concrete – application of curing agent as soon as possible and reduced heat/steam curing of concrete
- Formwork removal – fast early strength development for short formwork cycles
- Repair of any surface defects and damages – fast and easy application of suitable repair mortar or system
- Application of concrete protection – utilization of impregnation that offers intended protection purposes
- Transport of precast concrete element to construction site
- Repair of damages, which occurred during transportation – fast and easy application of suitable repair mortar or system
- Erection of elements and sealing of joints – highly durable sealing of joints according to technical requirements
- Final grouting of gaps and bonding / anchoring of built in parts

### ■ Preparation of concrete mix design

When preparing the design, the concrete requirements must be defined according to the specific elements, their intended use and exposure conditions. The following parameters should normally be defined:

- Strength requirements and durability requirements
- Aesthetic requirements
- Maximum aggregate diameter
- Method of placement and placing rate
- Concrete consistence
- General boundary conditions (temperature etc.)
- Handling of the concrete and its placing
- Definition of test requirements
- Consideration of the specific concrete element parameters
- Curing definition
- Mix design and specification

### ■ Concrete curing and hardening process

Since precasting generally involves continuous production, short intervals are required in all of the production phases. Curing is therefore particularly important because of its time constraints. Timing is the main reason for commonly used heat or steam curing, both highly energy consumptive measures. Despite timing, energy efficient and environmentally friendly production is becoming more and more important. Development of a suitable concrete mix design concept, including innovative superplasticizer technology and powerful accelerator technology, leads to an overall optimized production process in which energy consumption for heat or steam curing can be either reduced or even eliminated.

- Include the curing in the concrete design
- Use steam curing if necessary
- Prevent vibration (after finishing)
- Use a curing agent
- Cover with sheets or frost blankets
- Keep damp / moist or spray if necessary
- Maintain the curing time relevant to the temperature

Detailed information on curing is given in chapter 10.3 (see Page 238).



## ■ Improved concrete hardening in tunnel segment production

Tunnel segment production combines the challenge of realization of a specified high early strength and fulfilment of highest requirements regarding durability. Strength development is usually secured by utilization of heat or steam curing which can be contradictory to durability if the concrete core temperature is too high. The concrete performance regarding early strength and durability can be enhanced with the **SikaRapid®** technology.

Exemplary heating cycles with and without application of **SikaRapid®** and the resulting concrete temperature with the corresponding early strength can be seen in the graphics below. With the application of **SikaRapid®** the hardening process of the concrete was optimized, with the result that approximately 150 minutes of heating could be eliminated. At the same time the early and final strength requirements were attained. Moreover the durability of the tunnel segments was improved as the concrete peak temperature was limited to less than 60 °C.

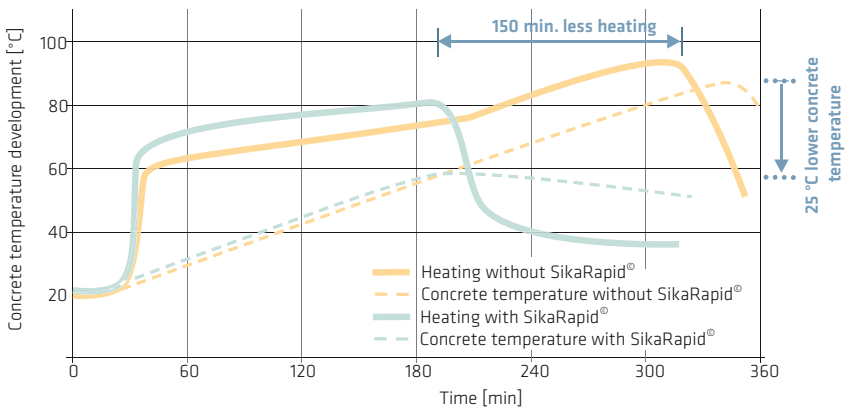

Fig. 6.10.1: Heating development and development of concrete temperature

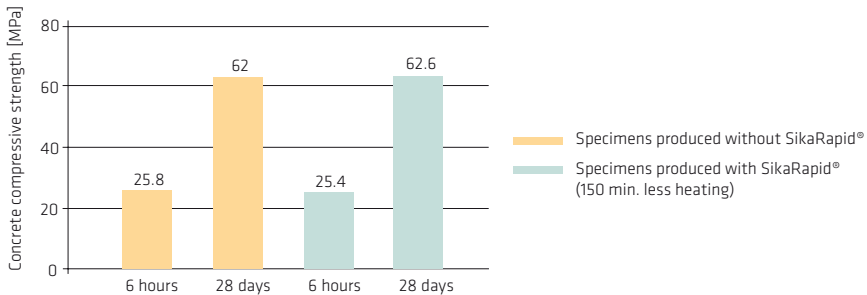

Fig. 6.10.2: Comparison of compressive strength

Table 6.10.1: For the overall wet precast production process and precast concrete element erection the following technologies are offered by Sika:

Concrete Production	Surface Appearance	Repair and Protection	Sealing and Bonding
Sikament®	Sika® Separol®	Sika® Antisol®	Sikaflex®
Sika® ViscoCrete®	SikaControl® PerFin	Sikagard®	Sikadur®
SikaRapid®	SikaColor®	Sika MonoTop®	Sika AnchorFix®
Sika® Stabilizer VMA	Sika® Rugasol®	SikaGrout®	
SikaControl® AER		Sikafloor®	
SikaFiber®		Sika® Ferrogard®	
SikaFume®			

### Sika product use

Product name	Product type	Product use
<b>Sika® ViscoCrete®</b> <b>Sikament®</b>	Superplasticizer	High water reduction, improved workability / self-compacting properties, increase of strength and durability
<b>SikaRapid®</b>	Accelerator	Control of setting and hardening of concrete
<b>Sika® Stabilizer VMA</b>	Viscosity modifying agent	Viscosity modifying admixture for improved stability and segregation resistance
<b>SikaControl® AER</b>	Air-entrainer	For the production of frost and freeze / thaw resistant concrete
<b>SikaControl® PerFin</b>	Surface improver	Improved finished concrete surfaces by the reduction of pores and blowholes
<b>SikaFiber®</b>	Micro fibers	Reduction of early age cracks, increase of fire resistance
	Macro fibers	Increase of impact resistance during handling and transport, replacement of steel reinforcement under certain conditions possible
<b>SikaFume®</b>	Silica fume	Supports the stability of the entrained air, increase of strength and durability
<b>SikaColor®</b>	Color pigments	For coloring concrete
<b>Sika® Separol®</b>	Mold release agent	For high quality concrete surfaces and mold protection
<b>Sika® Antisol®</b>	Curing agent	Protection from premature drying
<b>Sika® Rugasol®</b>	Surface retarder	Surface retarder

## 6.11 TUNNEL SEGMENT CONCRETE

Modern tunneling methods in weak rock conditions demand concrete segments which are immediately load bearing as linings to the fully excavated tunnel section. Precast concrete units called tunnel segments (Tübbing) perform this function.



### Production

Due to the large numbers required and heavyweight (up to several metric tons each), tunnel segments are almost always produced close to the tunnel portal in specially installed precasting facilities. They have to meet high accuracy specifications. Heavy steel formwork is therefore the norm. Because striking takes place after only 5 – 6 hours and the concrete must already have a compressive strength of  $>15 \text{ N/mm}^2$ , accelerated strength development is essential.

There are several methods for this. In the autoclave (heat backflow) process, the concrete is heated to 28 – 30 °C during mixing (with hot water or steam), placed in the form and finished. It is then heated for about 5 hours in an autoclave at 50 – 60 °C to obtain the necessary strength for formwork removal.

### Composition

#### ■ Aggregate

Commonly used: 0 – 32 mm

#### ■ Cement

Cement content 320 to 360  $\text{kg/m}^3$

CEM I 42.5 or 52.5

## Placing

The fresh concrete mix tends to stiffen rapidly due to the high temperature, making correct compaction and finishing of the surface difficult.

Due to the rapid industrialized processing, a plastic fresh concrete consistence can be used. The desired initial strength can only be obtained with a low w/c-ratio, which should therefore always be  $< 0.48$ .

## Special requirements

The newly demolded segments must be cured by covering or spraying with a curing agent such as **Sika® Antisol®**.

However, to obtain a combination of maximum durability in variable ground conditions and optimum curing, the segment surfaces are treated more often with a special **Sikagard®** protective coating immediately after striking. With this additional protection against chemical attack, extremely durable concrete surfaces are achieved.

## Sika product use

Product name	Product type	Product use
<b>Sika® ViscoCrete®</b>	Superplasticizer	High water reduction, improved workability, increase of strength and durability
<b>SikaRapid®</b>	Accelerator	Control of setting and hardening of concrete
<b>SikaControl® AER</b>	Air-entrainer	Air-entrainment, production of frost and freeze / thaw resistant concrete
<b>SikaFiber®</b>	Micro fibers	Reduction of early age cracks, increase of fire resistance
<b>SikaFume®</b>	Silica fume	Increase of strength and impermeability, improved sulfate resistance
<b>Sika® Separol®</b>	Mold release agent	For high quality concrete surfaces and mold protection



## 6.12 SEMI-DRY CONCRETE

Semi-dry concrete is used for the manufacture of precast concrete products having in common that they are economically produced in large quantities despite their large variety of shapes, textures and colors.

- Concrete paving stones / Pavers
- Building blocks
- Kerbstones
- Concrete paving tiles
- Gardening and landscaping elements
- Pipes and manholes
- Roof tiles
- Hollow core slabs
- Railway sleepers with instant demolding

Largest amount of semi-dry concrete is used for the manufacture of Pavers.



### General

The highly automated process needs special concrete characteristics:

- Granular aspect after mixing in order to ensure a fast and even filling of the mold.
- Demoldable instantly after compaction.
- Dimensional accuracy (shape keeping) despite entirely unhydrated cement (green strength).

One heavy compaction machine operating mostly in the vibro-press-system (vibration plus pressure) is required to manufacture concrete products in a large variety of shapes and sizes. The advantages of this process are:

- Only one mold per product shape (low capital investment)
- High production flexibility due to rapid changing of the formwork for a new product type
- Swift, efficient and industrialized production with high output

### Technology introduction

The semi-dry concrete mix design follows the same rules as conventionally vibrated concrete. However, some special conditions must be taken into account:

- Fine particle size distribution curve (max. particle size 8 mm with round aggregates, 11 mm with crushed aggregates) with high water demand
- Low total water content due to low w/b-ratio (0.34 to 0.40)
- Relatively low binder content (high strength cement in the face mix and an increasingly utilization of supplementary cementitious materials as cement substitutes e.g. fly ash or powdered limestone in the base mix)
- High content of compaction pores due to difficult compaction
- Susceptibility to early drying out and water loss due to unprotected large surface area related to small element volume

The strength develops according to the general laws of concrete technology and in the end is similar to high strength concretes.

## Compaction

The compactability of the used semi-dry concrete represents the most important factor for the product quality including shape-keeping, strength, discolorations and durability. It generally increases with:

- Increasing compaction energy (duration, frequency, etc.)
- Rising water content
- Higher binder content
- Addition of admixtures (compaction aids)

The compaction can be expressed the best using the compaction pore content, because this eliminates the influence of the specific aggregate density. A well compacted base mix should have  $\leq 5$  Vol.% compaction pores (typical  $\leq 8.5$  Vol.-%), while a high quality face mix can have  $\leq 8$  Vol.% compaction pores (typical  $\leq 12$  Vol.-%). These pores should be considered in the mix design calculation. The related fresh densities needs to be controlled during production.

Admixtures like SikaPaver® C- and HC-Series allow more rapid and intensive compaction. This offers the possibility to save compacting time or produce an increased and more homogeneous concrete quality.

## Water content

The water content of the concrete mix is decisive for a good compaction. Together with the cement it forms cement paste, which can be regarded as "lubricant". Higher amounts facilitate the moving of aggregates during compaction, leading to a better compaction. However, too much lubricant will negatively affect mold filling and green strength. If w/c-ratios exceed 0.40, additional capillary pores will occur, leading to final strength loss and less freeze/thaw resistance.

## Mold Filling

An even concrete distribution across the whole production board is necessary in order to ensure a low variation of the individual paver weights and hence leads to a constant quality. Special SikaPaver filling and compaction aids can help to improve the mold filling behavior with a granular semi-dry concrete.



## Green strength

The freshly formed concrete products have a so-called green strength which derives from the laws of soil mechanics (apparent cohesion). It is the reason why semi-dry concretes can be demolded immediately after compaction while keeping their shape. In standard paving stones with round aggregates this green strength (compressive) is in the range of approx. 0.1 – 1.0 MPa.

Positive effects can be achieved by a more intensive compaction (less pores) and the use of crushed aggregates. At constant pore content, more liquid cement paste and too high paste content will have a negative effect. However, at constant compaction energy, 6 l/m<sup>3</sup> more water ( $\approx$  w/c +0.02) will typically result in 1.5 Vol.-% less compaction pores and with that maintain the green strength.

## Strength

Semi-dry concrete paving stones are stored after production for about 24 hours on racks in a curing chamber. A typical climate of 35 °C/85% r.h. is reached also without additional heating if the chamber is isolated and protected against draught. After leaving the curing chamber, they need to withstand the stress of the palletizing units which is regarded as sufficient if the compressive strength exceeds 10 MPa.

Compressive strength and tensile splitting strength in general increase in relation to the concrete density (pore content). At constant compaction conditions (vibration time and compaction pressure), higher w/c-ratios lead to better compaction and hence higher strengths. However if the optimum water content is exceeded, the strength falls despite increasing fresh density. This occurs due to the strength-reducing capillary voids which form as a result of the excess water ( $w/c > 0.40$ ) and cancel out the positive effect of increasing density. The more cement substitutes are used at constant binder and water content, the sooner this effect occurs.

As a rule of thumb, best strengths are achieved if the targeted w/c-ratio for the base mix is 0.38 (typical w/c variation  $\pm 0.02$  due to changing aggregate moisture) which ensures a good cement hydration without capillary pores while in parallel reaching a good compaction. However, it is very important to find and maintain the best water content for the actual raw materials and mix design being used.

With SikaPaver® compaction aids (C- and HC- Series, typical dosage 0.3 M.-%), the concrete densities are increased at unchanged compaction conditions, leading to higher strengths. Even more important is the minimized range of strength variations despite unavoidable fluctuations in the base materials, e.g. in the water content. The resulting concrete mixes are more robust, enabling an optimization process and less second grade products.

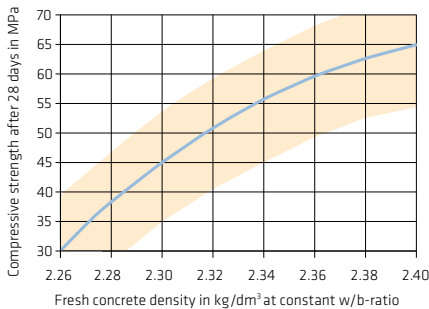

Fig. 6.12.1: Influence of density on compressive strength

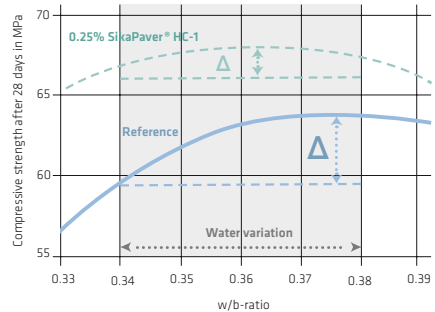

Fig. 6.12.2: Influence of w/b-ratio on compressive strength

## Efflorescence and other “discolorations”

The problem of efflorescence is commonly known as white ‘salt’ deposits which spoil the appearance of dark colored concrete pavers in particular. The worst cases occur when the efflorescence varies in intensity. This is generally the case for the most common type, the secondary efflorescence, which is created in the gaps between the individual layers of the palletized units during the outdoor storage in stacks. But also primary efflorescence, which tarnish the targeted brilliant color already during the storage in the climate chamber, can lead to customer complaints.

Efflorescence in general develop on the concrete surface if all following three conditions are given:

- Free calcium hydroxide  $\text{Ca}(\text{OH})_2$  (which is sufficiently available for all types of cement, also blended ones)
- Water-filled capillary voids (up to the concrete surface)
- Low evaporation rates due to climate (particular in autumn-winter when cooler) and blocked ventilation (tight storage)



Calcium hydroxide is transported to the concrete surface due to the concentration gradient of calcium ions in the moisture. The reaction of calcium hydroxide with the carbon dioxide ( $\text{CO}_2$ ) of the air forms the white calcium carbonate (limestone). Water is the primary conveyor. The larger the water absorption of the concrete (pore content), the longer the drying time of the pavers and hence the stronger the resulting efflorescence.

There is no cost effective way of absolutely preventing this. However, the following precautions can be taken to reduce efflorescence to a minimum degree:

- Dense concrete structure (compaction, binder and water content)
- Application of hydrophobic admixtures (water repellent efflorescence reducer) in both, the face and base concrete
- Low evaporation rate during storage (no draughts)
- Unrestricted air circulation (carbon dioxide) during initial hardening
- Ensure a high hydration degree at the point when products leave the climate chamber
- Protect stockpile from rain and condensation while maintain air circulation in order to ensure a fast drying in case of water penetration i.e. with basic roof structure.

Application of SikaPaver® anti-efflorescence admixture technology (AE-Series) leads to greatly reduced capillary water absorption of the paving stones, resulting in a substantially reduced potential for efflorescence. Nevertheless, a good concrete concept with low pore content is necessary to ensure the lowest efflorescence degree. This also applies to the reduction of brown or yellow discolorations as well as to the limitation of moss and lichens.





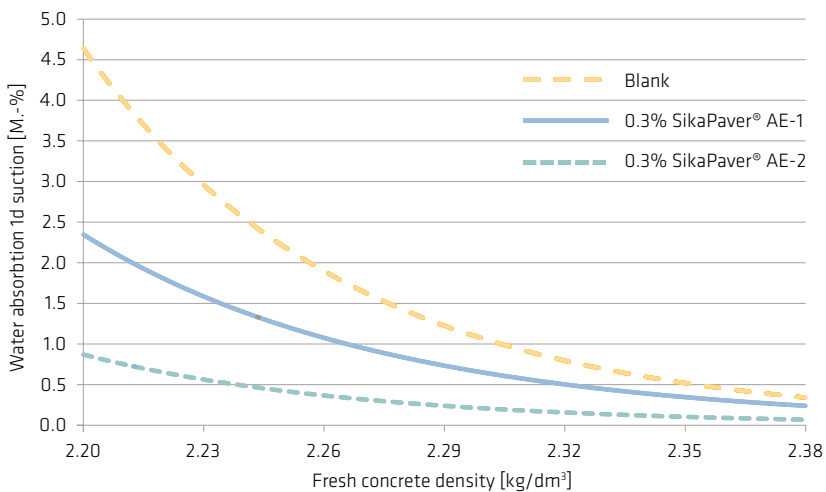

Fig. 6.12.3: Influence of SikaPaver® AE-types on water absorption in relation the concrete density

### Freeze / thaw resistance

The resistance of semi-dry concrete to repeated freeze / thaw cycles in contact with de-icing salts is tested according to the European standard EN 1338 with the slab test method. However, many producer, especially the ones who target high quality products, use the CDF test method which leads typically to higher scaling (material loss on the paver surface).

In general, a high quality semi-dry concrete with frost-proof aggregates has sufficient freeze / thaw resistance due to the low w/c-ratio in combination with a low pore content and a high cement hydration degree when leaving the curing chamber. Due to the many influencing factors like w/c-ratio (ideally between 0.36 and 0.40), compaction pore content, curing type / duration, aggregates and cement, suitability tests must be performed with the individual concrete design based on local material.

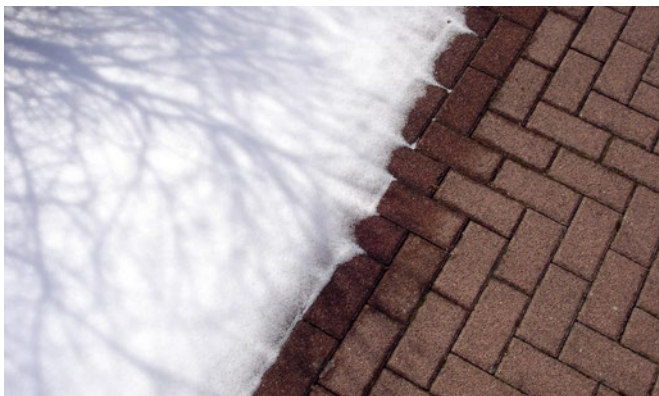

Table 6.12.1: SikaPaver® product range

	SikaPaver® C-1	SikaPaver® HC-1	SikaPaver® AE-1	SikaPaver® AE-2
Quick filling of forms	●	●●	●	●
Plasticizing / density	●●	●●●	●●	●
Smooth flanks with cement paste		●●●	●●	●
Anti-sticking-effect		●	●●	●●
Early strength (24 hours)	●	●●	●	●
Control strength (28 days)	●●	●●●	●●	●
Color intensification			●●●	●●
Reduction in efflorescence and water absorption			●●	●●●
Water repellent effect				●●●
	C = Compaction	HC = High Compaction	AE = Anti Efflorescence	

● moderate impact   ●● strong impact   ●●● very strong impact

### Sika product use

Product name	Product type	Product use
<b>SikaPaver® C-1</b>	Compaction aid for semi-dry concrete products	Production of standard products with improved compactability
<b>SikaPaver® HC-1</b>	High performance compaction aid for semi-dry concrete products with swipe formation	Cost effective production of high quality semi-dry concrete products with smooth flank
<b>SikaPaver® AE-1</b>	Efflorescence reducers and compaction aid for brilliant colors	Production of colored products with enhanced strength and durability
<b>SikaPaver® AE-2</b>	Efflorescence reducer with water repellent effect	Production of high quality products with long lasting resistance against efflorescence and moss formation

## 6.13 3D CONCRETE PRINTING

### Material solutions for 3D concrete printing

Over the last years additive manufacturing was discussed a lot in the construction industry. The possibility to automate construction procedures and the lack of well trained personnel are factors that lead to a higher importance of this discussion. Further to this the additive manufacturing leads to new possibilities for design and construction of buildings.

3D printing of cementitious materials has arrived in the construction industry and there are several companies on the market offering systems for 3D concrete printing, mainly with robot arms or with gantry types of printers. Both types of 3D concrete printers work with the extrusion of pre-mixed material and place the material in layers.



The requirements on the printed material depend on a number of factors, for example:

- Geometry of the printed element
- Required speed of printing
- Height of printing
- Batching or continuous mixing process
- Strength development
- Final strength
- Durability requirements
- Ambient conditions during printing
- Curing conditions



### Surface and appearance

One of the advantages of 3D printing is the freedom in design. Architects have completely new possibilities in designing geometries and surfaces with a cost effective method. Architectural concretes, like fair faced concrete or colored concrete have high requirements for the concrete surface. With the 3D printing new shapes, textures and colors of surfaces can be generated in a fast, easy and economically way. These new design opportunities lead to high requirements in precision, repeatability and consistency of the printed material.

With the experience gained over the last years with 3D printing of cementitious and other materials Sika is now able to develop materials that meet these requirements and lead to outstanding 3D prints regarding precision and surface appearance.

## Material and Printer

The result of a 3D cementitious print depends not only on the precision of the printing system, which is an important success factor, it also depends on the material which has to fit to the printer and to the application. For example the material requirements are different for an element printed inside under constant climate conditions than for an element printed outside. Also the printing system needs to be defined before choosing the right material for printing. For example a printer using a batch mixer has different requirements on the material than a fast continuous mixing process with large material throughput.

As the material is printed it is important to ensure a good bonding between the layers so that the structure is a homogeneous material. Depending on the geometry of the printed element the requirement on the setting time can be different. A too slow setting of the material can result in a very slow printing process as with increasing layers the pressure on the bottom layer increases.

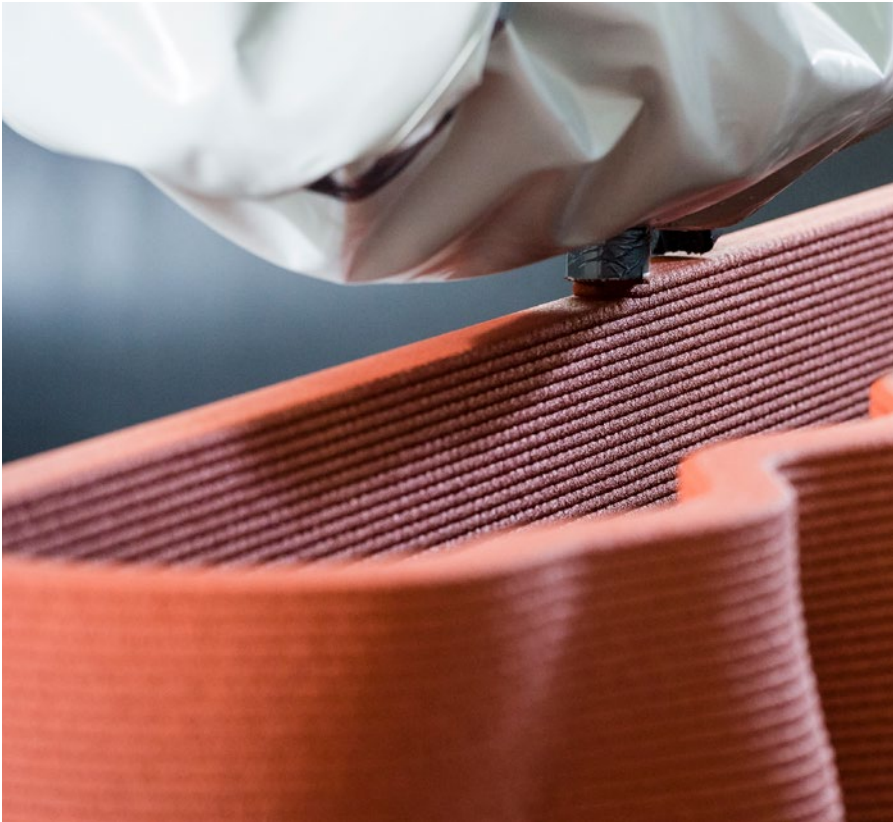

*Sika developed an own solution which is highly flexible in order to meet the customer requirements. The focus of this multi-component solution is pre-cast printing with high printing speed and high precision.*

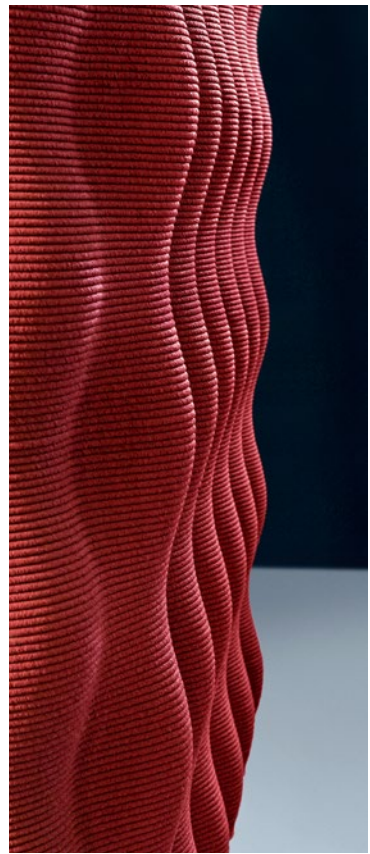

## Solutions

Sika has developed a multi-component system for 3D concrete printing including material supply, mixing technology, print head, gantry system and software control. Furthermore Sika develops one-component materials for customers already using a 3D printing system. This needs a close collaboration between the customer and Sika in order to supply the right material for the printing solution. With this system approach a material can be developed which leads to prints with the highest possible quality.



## Sika product use

Product name	Product type	Product use
<b>Sikacrete®</b>	One-component ready to use micro concrete	For most types of 3D concrete printers
<b>SikaGrout®</b>	Free flowing shrinkage compensated grout	Filling voids and bedding objects
<b>Sika® Antisol®</b>	Curing agent	Protect object from premature drying
<b>Sika® Color</b>	Concrete color (liquid or powder)	Even and intensive colored concrete
<b>Sika MonoTop®</b>	Levelling mortars and renders	For a smooth surface finish
<b>Sikagard®</b>	Hydrophobic impregnations and protective coatings	Change aesthetic appearance or extend durability
<b>Sika CarboDur®</b> <b>SikaWrap®</b>	Fiber Reinforced Polymer (FRP) Fabrics and Carbon Fiber Reinforced Polymer (CFRP) Plates	Surface mounted systems for structural strengthening of concrete substrates
<b>SikaDur®</b>	Epoxy adhesives	Rigid joint and stiff bond between objects
<b>Sikaflex®</b>	Elastic joint sealants	Building tightness, firestop and to accommodate movement between surfaces
<b>Sika® ViscoCrete®</b>	Superplasticizer	Hardening liquid admixtures
<b>Sika® Viscocrete®, SikaRapid®, SikaControl®</b>	Superplasticizers, accelerators and shrinkage reducers	Liquid admixtures for batched 3D concrete



# 7 HARDENED CONCRETE PROPERTIES AND TESTS

## 7.1 REQUIREMENTS FOR SPECIMENS AND MOLDS

### EN 12390-1

Terms from this standard:

- **Nominal size:**  
The common specimen size.
- **Specified size:**  
The specimen size in mm is selected from the permitted range of nominal sizes in the standard and used as the basis for the analysis.



**Permitted nominal sizes available for use (in mm)**

Cubes <sup>1</sup>	Edge length	100	150	200	250	300	
Cylinders <sup>2</sup>	Diameter	100	113 <sup>3</sup>	150	200	250	300
Prisms <sup>1 4</sup>	Edge length of face	100	150	200	250	300	

<sup>1</sup> The specified sizes must not differ from the nominal sizes.

<sup>2</sup> The specified sizes must be within 10% of the nominal size.

<sup>3</sup> This gives a load transfer area of 10'000 mm<sup>2</sup>.

<sup>4</sup> The length of the prisms must be  $\geq 3.5 d$ .

## Permitted tolerances for specimens

Permitted tolerances	Cubes	Cylinders	Prisms
Specified size	± 0.5%	± 0.5%	± 0.5%
Specified size between top area and bottom (base) area	± 1.0%		± 1.0%
Evenness of load transfer areas	± 0.0006 d in mm	± 0.0005 d in mm	
Squareness of sides in relation to the base area	± 0.5 mm	± 0.5 mm	± 0.5 mm
Height		± 5%	
Permitted straightness tolerance for the barrel line of cylinders used for splitting tests		± 0.2 mm	
Straightness of the area on the supports, for flexural tests			± 0.2 mm
Straightness of load transfer area, for tensile splitting strength tests			± 0.2 mm

### Molds

Molds must be waterproof and non-absorbent. Joints may be sealed with suitable material.

### Calibrated molds

These should be made of steel or cast iron as the reference material. If other materials are used, their long term comparability with steel or cast iron molds must be proven.

The permitted dimensional tolerances for calibrated molds are stricter than as defined above for standard molds.



# Making and Curing Specimens \*

\* **Note:** It is recommended that this standard should also be applied to all comparative concrete tests other than just the strength tests.

## EN 12390-2

### Notes on making specimens

- Stacking frame  
Pouring into the molds can be easier with an extension frame, but its use is optional.
- Compaction
  - Poker vibrator with a minimum frequency of 120 Hz (7'200 oscillations per minute).  
(Bottle diameter  $\leq \frac{1}{4}$  of the smallest dimension of the specimen.)
  - or
  - Table vibrator with a minimum frequency of 40 Hz (2'400 oscillations per minute).
  - or
  - Circular steel tamper x 16 mm, length approx. 600 mm, with rounded corners.
  - or
  - Steel compacting rod, square or circular, approx. 25 x 25 mm, length approx. 380 mm.
- Release agents  
These should be used to prevent the concrete from sticking to the mold.

### Notes on pouring

The specimens should be poured and compacted in at least 2 layers, but layers should be no thicker than 100 mm.

### Notes on compaction

When compacting by vibration, full compaction is achieved if no more large air bubbles appear on the surface and the surface has a shiny and quite smooth appearance. Avoid excessive vibration (release of air voids!).

Manual compaction with a rod or tamper: The number of impacts per layer depends on the consistence, but there should be at least 25 impacts per layer.

### Identification of specimens

Clear and durable labelling of the demolded specimens is important, particularly if they will then be conditioned for some time.

### Conditioning of specimens

The specimens must remain in the mold at a temperature of 20 ( $\pm 2$ ) °C, or at 25 ( $\pm 5$ ) °C in countries with a hot climate, for at least 16 hours but no longer than 3 days. They must be protected from physical and climatic shock and drying.

After demolding, the specimens should be conditioned until the test begins at a temperature of 20 ( $\pm 2$ ) °C, either in water or in a moisture chamber, at relative air humidity  $\geq 95\%$ . (In the event of dispute, water conditioning is the reference method).

# Specifications for Testing Machine

## EN 12390-4

This standard consists mainly of mechanical data: Pressure plates/force measurement/force regulation/force transmission.

For detailed information see the standard.

### Principle

The test specimen is placed between an upper movable pressure plate (spherical) and a lower pressure plate and an axial compressive force is applied until break occurs.

### Important notes

The test specimens must be correctly aligned in relation to the stress plane. The lower pressure plate must therefore be equipped with centering grooves, for example. The compression testing machine should be **calibrated** after initial assembly (or after dismantling and reassembly), as part of the test equipment monitoring (under the quality assurance system) or at least once a year. It may also be necessary after replacement of a machine part which affects the testing characteristics.

## Making and Curing Concrete Test Specimens in the Field

### ASTM C31

This practice covers procedures for making and curing cylinder and beam specimens from representative samples of fresh concrete for a construction project. The concrete used to make the molded specimens shall be sampled after all on-site adjustments have been made to the mixture proportions, including the addition of mix water and admixtures.

This practice is not satisfactory for making specimens from concrete not having measurable slump or requiring other sizes or shapes of specimens.

Molds for casting concrete test specimens shall conform to the requirements of Specification ASTM C470.

Report the following information:

- Identification number
- Location of concrete represented by the samples
- Date, time and name of individual molding specimens
- Slump, air content, and concrete temperature, test results and results of any other tests on the fresh concrete and any deviations from referenced standard test methods
- Curing method. For standard curing method, report the initial curing method with maximum and minimum temperatures and final curing method. For field curing method, report the location where stored, manner of protection from the elements, temperature and moisture environment, and time of removal from molds.

## 7.2 DENSITY

### Density of hardened concrete

#### Principle

The standard describes a method to determine the density of hardened concrete. The density is calculated from the mass (weight) and volume, which are obtained from a hardened concrete test specimen.



#### Test specimens

Test specimens with a minimum volume of 1 liter are required. If the nominal size of the maximum aggregate particle is over 25 mm, the minimum volume of the specimen must be over  $50 D^3$ , when D is the maximum aggregate particle size. (Example: Maximum particle size of 32 mm requires a minimum volume of 1.64 liters.)

#### Determining the mass

The standard specifies three conditions under which the mass of the specimen can be determined:

- As a delivered sample
- Water saturated sample
- Sample dried in warming cupboard (to constant mass)

#### Determining the volume

The standard specifies three methods to determine the volume of the specimen:

- By displacement of water (reference method)
- By calculation from the actual measured masses
- By calculation from checked specified masses (for cubes)

Determining the volume by displacement of water is the most accurate method and the only one suitable for specimens of irregular design.

**Test methods e.g.**      EN 12390-7    ASTM C157

## 7.3 COMPRESSIVE STRENGTH

### Compressive strength classes according to EN 206

An important property of hardened concrete is the compressive strength. It is determined by a compression test on specially produced specimens (cubes or cylinders) or cores from the structure.

The main factors influencing compressive strength are the type of cement, the w/c-ratio and the degree of hydration, which is affected mainly by the curing time and method.

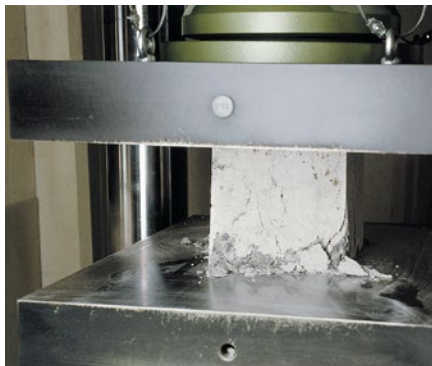

The concrete strength therefore results from the strength of the hydrated cement, the strength of the aggregate, the bond between the two components and the curing. Guide values for the development of compressive strength are given in the table below.

Table 7.3.1: Strength development of concrete (guide values<sup>1</sup>)

Cement strength class	Continuous storage at	3 days [%]	7 days [%]	28 days [%]	90 days [%]	180 days [%]
32.5 N	+ 20 °C + 5 °C	30 ... 40 15 ... 30	50 ... 65 40 ... 60	100 90 ... 105	100 ... 125	115 ... 130
32.5 R; 42.5 N	+ 20 °C + 5 °C	50 ... 60 20 ... 35	65 ... 80 40 ... 60	100 75 ... 90	105 ... 115	110 ... 120
42.5 R; 52.5 N	+ 20 °C + 5 °C	70 ... 80 20 ... 35	80 ... 90 35 ... 50	100 60 ... 75	100 ... 105	105 ... 110
52.5 R	+ 20 °C + 5 °C	80 ... 90 15 ... 25	90 ... 95 25 ... 45	100 45 ... 60	100 ... 103	103 ... 105

<sup>1</sup> The 28-day compressive strength at continuous 20°C storage corresponds to 100%.

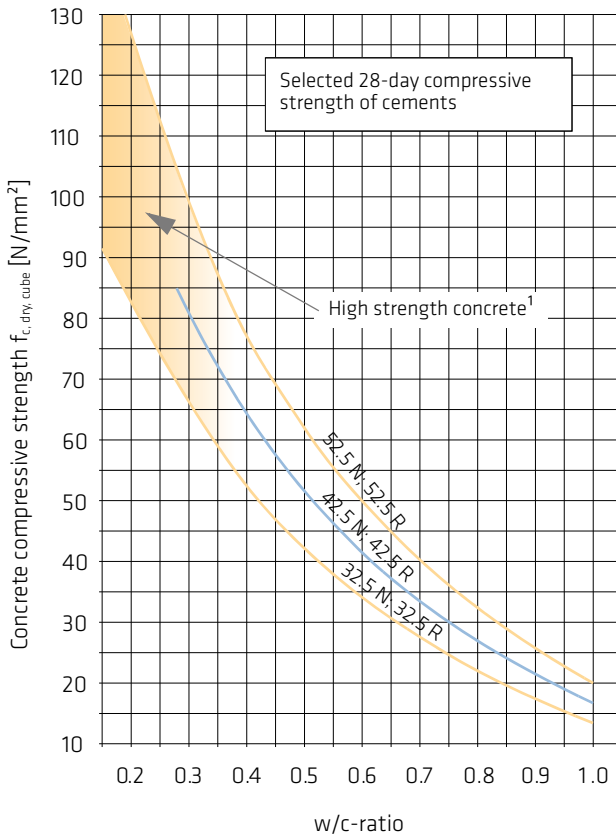

<sup>1</sup> In high strength concrete the influence of the standard compressive strength of the cement becomes less important.

Notes on the diagram:

- $f_{c, dry, cube}$  : - Average 28-day concrete compressive strength of 150 mm sample cubes.
- Storage according to DIN 1048; 7 days in water, 21 days in air.

Fig. 7.3.1: Correlation between concrete compressive strength, standard strength of the cement and w/c-ratio (according to Cement Handbook 2000, p.274)

## High early strength

High early strength is the needed compressive strength after a predefined amount of time. This time needed is defined by the application. In general it is within the first 24 hours after production.

### Parameters influencing high early strength concrete

Table 7.3.2: The strength development depend on the following parameters:

Parameter	Influence factor
CEM type	+++
CEM content	++
Additives (SF/Slag/FA)	+/-
Water content	+
Plasticizer/Superplasticizer	+/-
Accelerator	+++
Temperature (ambient, concrete, substrate)	+++
Curing	+/-
Aggregates	+

## Final strength

By definition a concrete reaches its final strength after 28 days even though the compressive strength may increase in time (see Table 7.3.1: Strength development of concrete).

### Parameters influencing final compressive strength

Table 7.3.3: The strength development depend on the following parameters:

Parameter	Influence factor
w/c-ratio	+++
CEM type	++
Additives (SF/Slag/FA)	++
Aggregates	+

The w/c-ratio is the decisive factor to influence the strength development/final strength and impermeability/durability of a concrete.

# Compressive Strength of Test Specimens

## EN 12390-3 / ASTM C39

Test equipment: Compressive testing machine according to EN 12390-4.

### Specimen requirements

The specimens must be cubes, cylinders or prisms. They must meet the dimensional accuracy requirements in EN 12390-1. If the tolerances are exceeded, the samples must be separated out, adapted or screened according to Annex B (normative). Annex B gives details of how to determine the geometric dimensions.

One of the methods described in Annex A (normative) is used for adaptation (cutting, grinding or applying a filler material).

Cube samples should be tested perpendicular to the direction of pouring (when the cubes were made).

At the end of the test, the type of break should be assessed. If it is unusual, it must be recorded with the type number.

Fig. 7.3.2: Standard break patterns  
(illustrations from the standard)



Fig. 7.3.3: Unusual break patterns on cubes  
(illustrations from the standard)

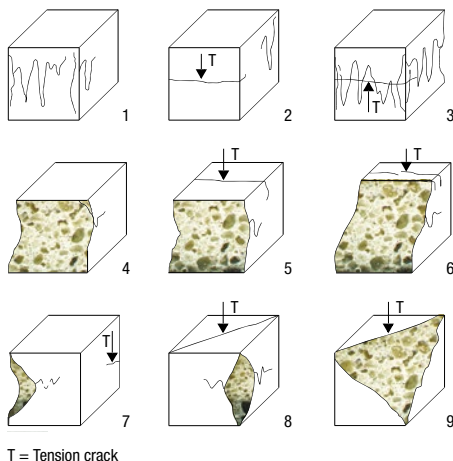

### Schematic of typical fracture patterns according to ASTM C39

This test method covers determination of compressive strength of cylindrical concrete specimens such as molded cylinders and drilled cores. It is limited to concrete having a density in excess of 800 kg/m<sup>3</sup> [50 lb/ft<sup>3</sup>].

This test method consists of applying a compressive axial load to molded cylinders or cores at a rate which is within a prescribed range until failure occurs. The compressive strength of the specimen is calculated by dividing the maximum load attained during the test by the cross-sectional area of the specimen.

Molds and specimen have to be in accordance to ASTM C470 and ASTM C31.

The compressive load has to be applied until the load indicator shows that the load is decreasing steadily and the specimen displays a well-defined fracture pattern (s. Fig. 7.3.4).

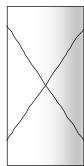

**Type 1**  
Reasonably well-formed cones on both ends, less than 1 in. (25 mm) of cracking through caps

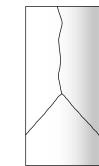
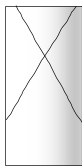

**Type 2**  
Well-formed cone on one end, vertical cracks running through caps, no well-defined cone on other end

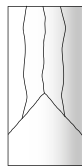

**Type 3**  
Columnar vertical cracking through both ends, no well-formed cones

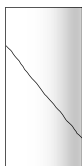

**Type 4**  
Digital fracture with no cracking trough ends; tap with hammer to distinguish from Type 1



**Type 5**  
Side fractures at top or bottom (occur commonly with unbonded caps)



**Type 6**  
Similar to Type 5 but end of cylinder is pointed

Fig. 7.3.4: Fracture patterns according to ASTM C39

For Lightweight Insulating Concrete ASTM C495 applies.



## **Non destructive testing of compressive strength**

### **ASTM C805 Standard test method for rebound number of hardened concrete**

This test method covers the determination of a rebound number of hardened concrete using a spring-driven steel hammer.

It is applicable to assess the in-place uniformity of concrete, to delineate regions in a structure of poorer quality or deteriorated concrete, and to estimate in-place strength. Relationships between rebound number and concrete strength that are provided by instrument manufacturers shall be used only to provide indications of relative concrete strength at different locations in a structure. To use this test method to estimate strength, it is necessary to establish a relationship between strength and rebound number for a given concrete mixture and given apparatus. Establish the relationship by correlating rebound numbers measured on the structure with the strengths of cores taken from corresponding locations. At least two replicate cores shall be taken from at least six locations with different rebound numbers. Select test locations so that a wide range of rebound numbers in the structure is obtained. Obtain, moisture condition, and test cores in accordance with Test Method C42/C42M.

For a given concrete mixture, the rebound number is affected by factors such as moisture content of the test surface, the method used to obtain the test surface (type of form material or type of finishing), vertical distance from the bottom of a concrete placement, and the depth of carbonation. These factors need to be considered in interpreting rebound numbers.

Different hammers of the same nominal design may give rebound numbers differing from 1 to 3 units. Therefore, tests should be made with the same hammer in order to compare results. If more than one hammer is to be used, perform tests on a range of typical concrete surfaces so as to determine the magnitude of the differences to be expected. This test method is not suitable as the basis for acceptance or rejection of concrete.

### **EN 12504-2 Testing concrete in structures – Part 2: Non-destructive testing – Determination of rebound number**

Methodology similar as ASTM C805

## 7.4 FLEXURAL STRENGTH

Concrete is basically used under compressive stress and the tensile forces are absorbed by reinforcement bars. Concrete itself has some tensile and flexural strength, which is strongly dependent on the mix. The critical factor is the bond between aggregate and hydrated cement. Concrete has a flexural strength of approximately  $2 \text{ N/mm}^2$  to  $7 \text{ N/mm}^2$ .



### Influences on flexural strength

#### Flexural strength increases

- As the standard cement compressive strength increases (CEM 32.5; CEM 42.5; CEM 52.5)
- As the w/c-ratio decreases
- By the use of angular and crushed aggregate
- By the use of Sika Silica fume technology

#### Typical Applications

- Steel fiber reinforced concrete
- Runway / Road concrete
- Shell structure concrete



**Test methods e.g.** EN 12390-5    ASTM C78

## EN 12390-5 or ASTM C78 Using Simple Beam with Third-Point Loading

### Principle

A bending moment is exerted on prism test specimens by load transmission through upper and lower rollers.

- Prism dimensions:  
Width = height =  $d$   
Length  $\geq 3.5 d$

Two test methods are used:

- 2-point load application  
Load transfer above through 2 rollers at a distance  $d$  (each one  $\frac{1}{2} d$  from center of prism).  
The reference method is 2-point load application.
- 1-point load application (central)  
Load transfer above through 1 roller, in center of prism.

In both methods the lower rollers are at a distance of  $3 d$  (each one  $\frac{1}{2} d$  from center of prism).

Analyses have shown that 1-point load transfer gives results about 13 % higher than 2-point load transfer.

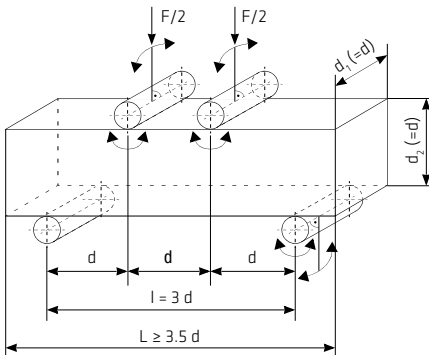

Fig. 7.4.1: Two-point load transfer

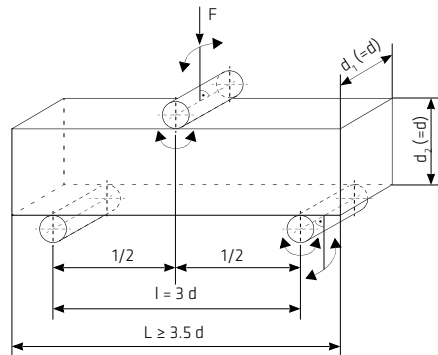

Fig. 7.4.2: Central load transfer

## 7.5 TENSILE STRENGTH

### Tensile splitting strength of test specimens

#### Principle

A cylindrical test specimen is subjected to a compressive force applied immediately adjacent along its longitudinal axis. The resultant tensile force causes the test specimen to break under tensile stress.



#### Test specimens

Cylinders according to EN 12390-1, but a diameter to length ratio of 1 is permissible.

If the tests are carried out on cube or prism specimens, convex steel spacers may be used for load application (instead of conventional flat plates).

The broken specimen should be examined and the concrete appearance and type of break recorded if they are unusual.



**Test methods e.g.** EN 12390-6 ASTM C496

## 7.6 YOUNG'S MODULUS OF ELASTICITY (E-MODULUS)

The Young's Modulus of Elasticity (E-Modulus) describes the hardened concrete performance regarding its elastic deformation resistance. The E-Modulus describes the relation between an influencing stress and the corresponding elastic deformation (stress-strain relation). It can be distinguished between the static and the dynamic Young's Modulus of Elasticity.

The static E-Modulus characterizes the deformation resistance of concrete against a constantly increasing or steady impact. The dynamic E-Modulus is suitable for investigation of the maturity of concrete, e.g. hardening process or for measurement of weathering or any potential deteriorating influences (laboratory or field test specimens).



### Static modulus of Elasticity according to DIN 1048-5

According to DIN 1048-5 the static E-Modulus is evaluated between a lower stress limit of  $\sigma_u \approx 0.5 \text{ N/mm}^2$  and an upper stress limit of  $\sigma_o \approx 1/3 \beta_o$ , after two times of loading and load removal. With a third loading cycle the static E-Modulus is evaluated as follows:

$$E_b = \frac{\sigma_o - \sigma_u}{\epsilon_o - \epsilon_u} \quad [\text{N/mm}^2]$$

$\sigma_u$  = lower stress limit before the third loading ( $\sigma_u \approx 0.5 \text{ N/mm}^2$ )

$\sigma_o$  = upper stress limit at the third loading

$\beta_o$  = expected compressive strength

(evaluated compressive strength (average of 3 samples))

$\epsilon_u$  = strain at the corresponding stress  $\sigma_u$

$\epsilon_o$  = strain at the corresponding stress  $\sigma_o$

## Dynamic Modulus of Elasticity

The dynamic E-Modulus can be derived by measuring an ultrasonic spreading time with the following approach:

$$E_{\text{dyn}} = C * \rho * c^2$$

C = dimensionless constant  
c = spreading velocity within the material  
 $\rho$  = concrete density

## Static Modulus of Elasticity according to ASTM C469 - 02

The described method for evaluation of the static E-Modulus offers a stress to strain relation and a ratio of lateral to longitudinal strain for hardened concrete within the customary working stress range (0 to 40% of ultimate concrete strength).

Prior measurement the specimen should be loaded twice. Then the applied load and longitudinal strain should be recorded, when

- The longitudinal strain is 50 millionths, and
- The applied load is equal to 40% of the ultimate load.

The E-Modulus is calculated by:

$$E = \frac{S_2 - S_1}{\epsilon_2 - 0.000050}$$

E = chord modulus of elasticity [psi]  
S<sub>2</sub> = stress corresponding to 40% of ultimate load  
S<sub>1</sub> = stress corresponding to a longitudinal strain,  $\epsilon_1$ , of 50 millionths [psi]  
 $\epsilon_2$  = longitudinal strain corresponding to stress S<sub>2</sub>

## Dynamic Modulus of Elasticity according to ASTM C215 - 08

The test method provides data for detecting significant changes in the dynamic modulus of elasticity by measuring the fundamental transvers, longitudinal, and torsional resonant frequencies of concrete specimens.

The fundamental resonant frequencies are determined by two alternative procedures:

- The forced resonance method – a supported specimen is forced to vibrate by an electro-mechanical driving unit and the specimen response is monitored by a lightweight pickup unit on the specimen,
- The impact resonance method – a supported specimen is struck with a small impactor and the specimen response is measured by a lightweight accelerometer on the specimen.

## 7.7 SHRINKAGE

Shrinkage means the contraction or decrease in volume of the concrete. The time sequence and shrinkage deformation level are influenced mainly by the start of drying, ambient conditions and the concrete composition.



### The time sequence breaks down as follows:

- Chemical shrinkage of the new concrete is due only to the difference in volume between the reaction products of hydrated cement and unhydrated cement. Shrinkage affects only the cement matrix, not the aggregate.
- Plastic shrinkage of the new concrete occurs in the initial stage of setting and hardening. Water is drawn out of the concrete after the initial set by evaporation, which reduces the volume and results in contraction of the concrete in every direction. The deformation usually stops when the concrete reaches a compressive strength of  $1 \text{ N/mm}^2$ .
- Drying shrinkage → Shrinkage caused by the slow drying of the hardened concrete, i.e. the quicker the quantity of free water in the structure decreases, the more the concrete shrinks.

### Influences on the degree of shrinkage:

- Planning and detailed specification of construction joints and concreting stages
- Optimized mix design
- Lowest possible total water content → use of **Sika® ViscoCrete®/SikaPlast®/Sikament®**
- Shrinkage reduction admixture **SikaControl® SRA** → reduction of shrinkage after the start of hydration
- Prevention of water extraction by pre-wetting the formwork and substrate
- Thorough curing: by covering with plastic sheets or insulating blankets, water-retaining covers (hessian, geotextile matting) or spraying with a liquid curing agent **Sika® Antisol®**
- Reinforcement

**Test methods e.g.** ASTM C157 SIA 262/1

Phase I	Phase II	Phase III
<b>Chemical shrinkage</b>	<b>Plastic shrinkage</b>	<b>Drying shrinkage</b>
Recompaction	Prevent water loss	Curing/Shrinkage reduction
approx. 4 – 6 hours	approx. 1 N/mm <sup>2</sup>	

Table 7.7.1: Shrinkage type during hydration of concrete

### ASTM C157 Standard test method for length change of hardened hydraulic-cement mortar and concrete

Measurement of length change permits assessment of the potential for volumetric expansion or contraction of mortar or concrete due to various causes other than applied force or temperature change. This test method is particularly useful for comparative evaluation of this potential in different hydraulic-cement mortar or concrete mixtures. This test method provides useful information for experimental purposes or for products that require testing under nonstandard mixing, placing, handling, or curing conditions, such as high product workability or different demolding times.

If conditions for mixing, curing, sampling, and storage other than specified in this test method are required, they shall be reported but are not to be considered as standard conditions of this test method. Nonstandard conditions and the reasons for departure from standard conditions shall be reported clearly and prominently with comparator values.

### SIA 262/1 Concrete construction – additional requirements

This test method provides a means of assessing the change of length over time caused by the drying process of a concrete sample. Size of the prism is 120 × 120 × 360 mm. For a test at least two prisms have to be measured. After 24 h (± 1h) of concrete production the length of every dimension of the concrete sample has to be measured and is used as the reference value. Further measurements have to be taken after 3, 7, 14, 28, 91, 182 and 364 days after concrete production. The result will be expressed in ‰ shrinkage.



## 7.8 WATERTIGHTNESS

The watertightness defines the resistance of the concrete structure against the penetration of water. The watertightness of concrete is determined by the impermeability (capillary porosity) of the hydrated cement.



### Definition of watertightness

- Max. penetration depth (EN 12390-8) has to be agreed by the involved parties (Sika recommendation < 30 mm)
- Requirement: Good concrete quality and the right solution for joint design!

In the US there is no ASTM standard for watertightness instead following methods are used:

- CRD-C 48-92 Standard Test Method for Water Permeability of Concrete.
- ASTM C 1585 Standard Test Method for Measurement of Rate of Absorption of Water by Hydraulic-Cement Concretes.

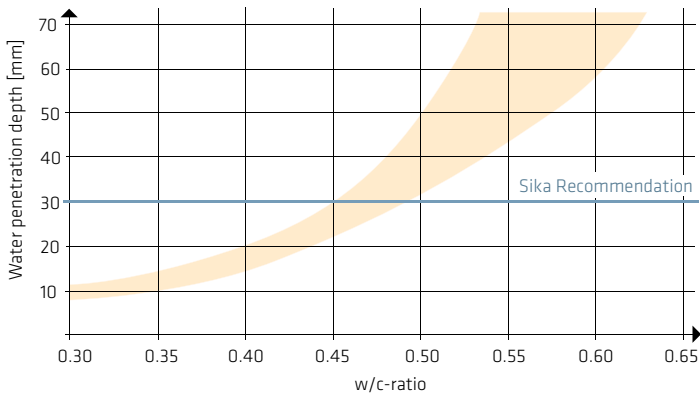

Fig. 7.8.1: Water penetration depth according to EN 12390-8

## Definition of water impermeability

- Water conductivity  $q_w <$  evaporable water volume  $q_d$

→ The higher the wall thickness  $d$  is, the better the watertightness

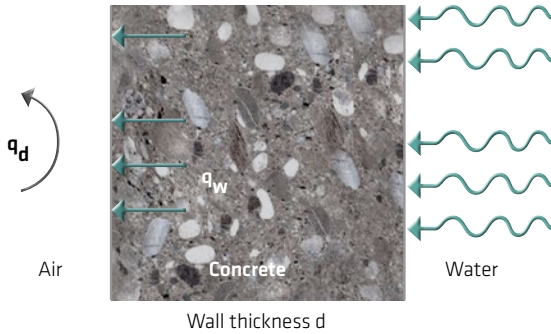

Fig. 7.8.2: Principle of water conductivity

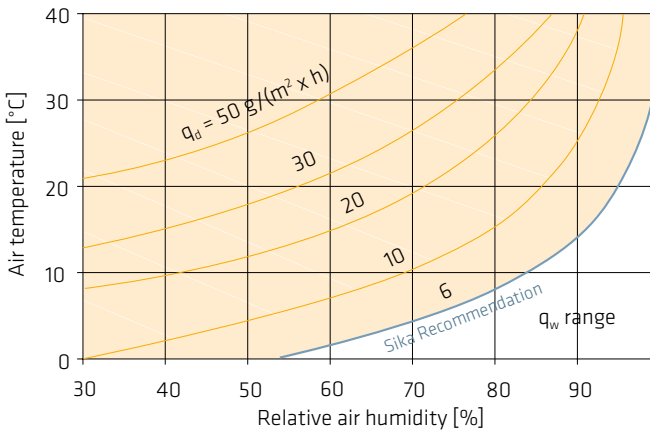

Fig. 7.8.3: Water conductivity according to SIA 262/1 Annex A

- Recommended range for watertight structures:  $q_w \leq 6 \text{ g}/(\text{m}^2 \times \text{h})$
- Load**  
Variable saturation due to continuous water contact
- Test**  
Measurement of water conductivity  $q_w$

## Reduction of capillary voids and cavities by water reduction

### High w/c-ratio > 0.60

Large voids due to absence of fine sand and fines

### Low w/c-ratio < 0.40

Very dense cement matrix

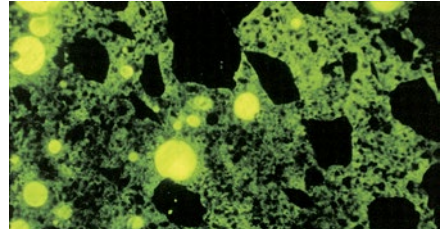
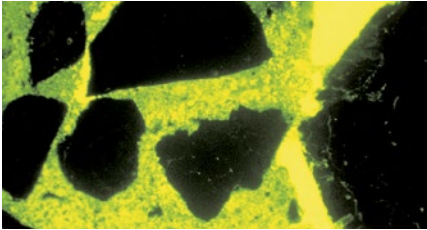

Fig. 7.8.4: Porosity of concrete at different w/c-ratios

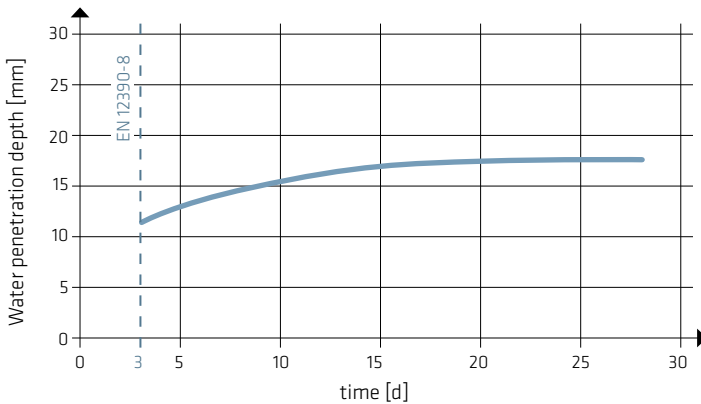

Fig. 7.8.5: Water penetration depth under 5 bar pressure over time (special mix design for waterproof concrete)

Proper hydration is of primary importance for watertight concrete. Therefore correct curing of the concrete is essential.

**Test methods e.g.** EN 12390-8 ASTM C1012 CRD-C 48-92

## EN 12390-8: Depth of penetration of water under pressure

### Principle

Water is applied under pressure to the surface of hardened concrete. At the end of the test period the test specimen is split and the maximum depth of penetration of water is measured.

### Test specimens

The specimens are cubes, cylinders or prisms with a minimum edge length or diameter of 150 mm.

The test area on the specimen is a circle with a 75 mm diameter (the water pressure may be applied from above or below).

### Conditions during the test

- The water pressure must not be applied on a smoothed / finished surface of the specimen (preferably take a shuttered lateral area for the test). The report must specify the direction of the water pressure in relation to the pouring direction when the specimens were made (at right angles or parallel).
- The concrete surface exposed to the water pressure must be roughened with a wire brush (preferably immediately after striking of the specimen).
- The specimens must be at least 28 days old at the time of the test.

### Test

During 72 hours, a constant water pressure of 500 ( $\pm$  50) kPa (5 bar) must be applied. The specimens must be regularly inspected for damp areas and measurable water loss. After the test the specimens must be immediately removed and split in the direction of pressure. When splitting, the area exposed to the water pressure must be underneath. If the split faces are slightly dry, the directional path of penetration of water should be marked on the specimen.

The maximum penetration under the test area should be measured and stated to the nearest 1 mm.

### ASTM C1585: Standard test method for measurement of rate of absorption of water by hydraulic-cement concretes

This test method is used to determine the rate of absorption (sorptivity) of water by hydraulic cement concrete by measuring the increase in the mass of a specimen resulting from absorption of water as a function of time when only one surface of the specimen is exposed to water. The exposed surface of the specimen is immersed in water and water ingress of unsaturated concrete dominated by capillary suction during initial contact with water.

## 7.9 FROST AND FREEZE / THAW RESISTANCE

### Frost stress

Damage to concrete structures due to frost can generally be expected when those have been penetrated by moisture and are exposed to frequent freeze / thaw cycles in that condition. The damage to the concrete occurs due to the cyclic freezing and thawing of the water which has been absorbed due to capillary suction. Destruction follows due to the increase in volume of the water [ice] in the outer concrete layers.



### Essentials for high frost resistance

- Frost-proof aggregates
- Impermeable concrete structure and/or
- Concrete enriched with micropores ( $\leq 300 \mu\text{m}$ )
- Thorough and careful curing
- Degree of hydration of the concrete as high as possible (i.e. it is not a good idea to place concrete immediately before periods of frost)

### Freeze / thaw resistance

Given the extensive use of de-icing salts (generally sodium chloride NaCl, intended to lower the freezing point of the water on roads and prevent ice formation etc.), the concrete surface cools abruptly due to heat extraction from the concrete. These interactions between frozen and unfrozen layers cause structural breakdown in the concrete.

### Conditions for freeze / thaw resistance

- Frost-proof aggregates
- Concrete with a dense structure enriched with micropores
- Thorough and careful curing
- Avoid too much fine mortar deposits on the surface area
- Concreting as long as possible before the first freeze / thaw stress so that the concrete can dry out

**Test methods e.g.**      Pre Standard CEN/TS 12390-9    ASTM C666

## EN 12390-9 (2006: Pre-standard) Testing hardened concrete. Freeze / thaw resistance

The standard describes how to test the frost resistance of concrete with water and the freeze / thaw resistance with NaCl solution ('salt water'). The amount of concrete which has separated from the surface after a defined number and frequency of freeze / thaw cycles is measured.

### Principle

Specimens are repeatedly cooled to temperatures partly below  $-20^{\circ}\text{C}$  and reheated to  $+20^{\circ}\text{C}$  or over (in water or a common salt solution). The resultant amount of material separation indicates the available frost or freeze / thaw resistance of the concrete.

### Three methods are described:

- Slab test method
- Cube test method
- CD/CDF test method
- The slab test method is the reference method.

### Terms from the pre-standard

- Frost resistance:
  - Resistance to repeated freeze / thaw cycles in contact with water
- Freeze / thaw resistance:
  - Resistance to repeated freeze / thaw cycles in contact with de-icing agents
- Scaling:
  - Material loss on the concrete surface due to the action of freeze / thaw cycles
- Internal structure breakdown:
  - Cracks within the concrete which are not visible on the surface but which produce a change in the concrete characteristics such as a reduction in the dynamic E-modulus

## 7.10 ABRASION RESISTANCE

Concrete surfaces are exposed to rolling stress (wheels / traffic), grinding stress (skids / tires) and/or impact stress (bulk materials / liquids). The cement matrix, the aggregates, and their bond are all equally stressed. This attack is therefore primarily mechanical.



### Conditions for better abrasion resistance

The abrasion resistance of the hydrated cement is lower than that of the aggregate, particularly with a porous cement matrix (high water content). However, as the w/c-ratio decreases, the porosity of the hydrated cement decreases as well and the bond with the aggregate improves.

- Ideal: w/c-ratio equal or lower than 0.45
- Improvement of the density of the hydrated cement matrix, the bond of the aggregate and the hydrated cement (**SikaFume®**)
- Selection of a good grading curve, using special sizes if necessary, thorough curing
- To increase the abrasion resistance still further, special aggregates should also be used

If the layer thickness exceeds 50 mm, a light reinforcement mesh should normally be incorporated (min. 100×100×4×4 mm).

### Adhesion to the substrate and finishing

- Before installation, a 'bond coat' is brushed into the slightly damp substrate (pre-wetted!)

### Curing

Curing has to start as early as possible and should be maintained for sufficient period of time, by spraying **Sika® Antisol®** (Attention! Take any subsequent coating into consideration!) or by covering with sheets.

**Test methods e.g.** ASTM C779    ASTM C418    ASTM C944    DIN 52108

## **ASTM C779 Standard test method for abrasion resistance of horizontal concrete surfaces**

The three test methods described in this standard, provide simulated abrasion conditions, which can be used to evaluate the effects on abrasion resistance of concrete, concrete materials, and curing or finishing procedures. They may also be used for quality acceptance of products and surface exposed to wear. They are not intended to provide a quantitative measurement of length of service.

The equipment used by each of these procedures is portable and thus suitable for either laboratory or field testing.

The procedures differ in the type and degree of abrasive force they impart, and are intended for use in determining variations in surface properties of concrete affected by mixture proportions, finishing, and surface treatment. They are not intended to provide a quantitative measurement of the length of service that may be expected from a specific surface.

## **DIN 52108 Testing of inorganic non-metallic materials – wear test using the grinding wheel according to Böhme – Grinding wheel method**

This test method provides simulated abrasion conditions using a grinding wheel. Cubes or plates are tested under norm conditions according to the procedure described in DIN 52108. The result is either a loss in thickness or loss in volume of the specimen.



## 7.11 CHEMICAL RESISTANCE

Concrete can be attacked by contaminants in water, soil or gases (e.g. air). Hazards also occur in service (i.e. in tanks, industrial floors, wastewater treatment facilities etc.).

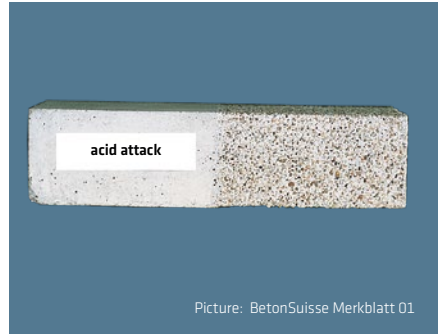

- Surface and ground water, harmful soil contaminants, air pollutants, vegetable and animal substances can attack the concrete chemically
- Chemical attack can be divided into two types:
  - Dissolvent attack: caused by the action of soft water, acids, salts, bases, oils and greases etc.
  - Swelling / spalling attack: caused mainly by the action of water soluble sulfates (sulfate swelling)

### Measures

- Concrete matrix as dense as possible,  
i.e. low porosity → use of the Sika Silica fume technology  
→ **SikaFume®**
- Low w/c-ratio aim for  $\leq 0.45$   
→ **Sika® ViscoCrete® / SikaPlast® / Sikament®**
- Increase the concrete cover by 10 mm minimum

Concrete only has adequate resistance against very weak acids. Medium strength acids degrade the concrete. Therefore extra protection of the concrete with a coating must always be specified for moderate to highly aggressive acid attack.

### Test methods e.g.

There is no standard covering all kind of chemical attack.

EN 13529      AASHTO T 259      ASTM C1202



## 7.12 SULFATE RESISTANCE

Water containing sulfate sometimes occurs in soil or dissolved in ground water and can attack the hardened concrete.

### Process

Water containing sulfate reacts with the tricalcium aluminate hydrates (AFm) in the cement. As a result ettringite forms (also thaumasite under certain conditions), which leads to increases in volume and to high internal pressure in the concrete structure and therefore cracking and spalling occurs.

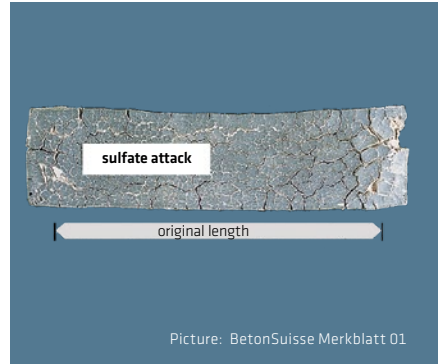

### Measures

- Concrete structure as impermeable as possible
  - i.e. low porosity → use of the Sika Silica fume technology  
→ **SikaFume®**
- Low w/c-ratio aim for  $\leq 0.45$   
→ **Sika® ViscoCrete® / SikaPlast® / Sikament®**
- Use cement with a low amount of tricalcium aluminate ( $C_3A$ ) content
- Curing suited to the structure

**Note:** Clarification of specific requirements is essential for every project.

Limiting values for exposure classification of chemical attack from natural soil and ground water (see Page 244).

### Test methods e.g.

ASTM C1012      SIA 262/1

## ASTM C1012 Standard test method for length change of hydraulic-cement mortars exposed to a sulfate solution

This test method provides a means of assessing the sulfate resistance of mortars made using Portland cement, blends of Portland cement with pozzolans or slags, and blended hydraulic cements.

The standard exposure solution used in this test method, unless otherwise directed, contains 352 moles of  $\text{Na}_2\text{SO}_4$  per  $\text{m}^3$  (50 g/L). Other sulfate concentrations or other sulfates such as  $\text{MgSO}_4$  may be used to simulate the environmental exposure of interest. This test method covers the determination of length change of mortar bars immersed in a sulfate solution.

### SIA 262/1 Concrete construction – additional requirements

This test method provides a means of assessing the sulfate resistance of a concrete sample. Concrete samples have to be prepared according to EN 206. For four cycles samples have to be dried and stored in a sulfate containing solution (5% sodium sulfate solution). The sulfate might react with parts of the samples and causes a volumetric change of the sample.



## 7.13 AAR RESISTANCE

Alkali-Aggregate Reaction (AAR) means reactions of the pore solution of the concrete with the aggregates. They produce a silica gel which swells due to water absorption and causes cracking or spalling in the concrete.

The form and rate of the reaction vary according to the type of aggregate.

- Alkali-Silica Reaction (ASR) with volcanic aggregates
- Alkali-Carbonate Reaction (ACR) with limestone

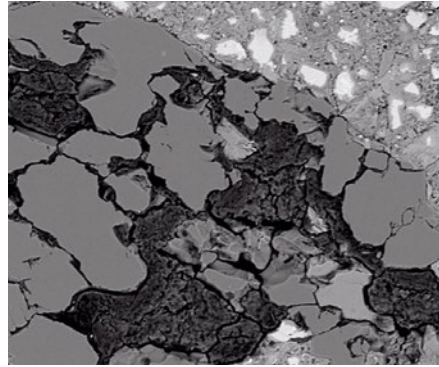

### Alkali-Aggregate Reaction

There is a risk of this reaction when using alkali-sensitive aggregates. The problem can obviously be overcome by not using these aggregates – but this is often impractical for economic and ecological reasons. By using suitable cements and high performance concrete technology, this reaction can be prevented or at least reduced.

The precise mechanisms involved continue to be intensively analyzed in great detail.

Roughly speaking, alkali ions penetrate the aggregates by water absorption, and generate an expansion of the aggregates. This leads to cracking and spalling of the cement matrix, destroying the concrete. This can be described in simple terms as a pressure or expansion effect. Its duration and intensity depend on the reactivity of the cement, type and porosity of the aggregate, the porosity of the concrete and the preventative measures taken.

### Measures:

- Partial replacement of the Portland cement by slag or other additions (silica fume / fly ash) with low equivalent  $\text{Na}_2\text{O}$
- Analysis of the AAR/ASR potential of the aggregate and its classification (petrographic analyses/microbar test/performance testing etc.)
- Replacement or partial replacement of the aggregates (blending of available aggregates)
- Keep moisture access to the concrete low or prevent it (seal/divert)
- Reinforcement design for good crack distribution in the concrete (i.e. very fine cracks only)
- Impermeable concrete design to minimize the penetration of moisture

**Test methods e.g.** ASTM C1260 AFNOR P 18-454 AFNOR XPP 18-594

## **ASTM C1260 Test method for potential alkali reactivity of aggregates (Mortar-Bar method)**

This test method provides a means of detecting the potential of an aggregate intended for use in concrete for undergoing alkali-silica reaction resulting in potentially deleterious internal expansion. It is based on the NBRI Accelerated Test Method (1-4). It is especially useful for aggregates that react slowly or produce expansion late in the reaction. However, it does not evaluate combinations of aggregates with cementitious materials nor are the test conditions representative of those encountered by concrete in service. Because the specimens are exposed to a NaOH solution, the alkali content of the cement is not a significant factor in affecting expansions.

When excessive expansions (see Appendix X1) are observed, it is recommended that supplementary information be developed to confirm that the expansion is actually due to alkali-silica reaction. Sources of such supplementary information include:

- Petrographic examination of the aggregate (Guide C295) to determine if known reactive constituents are present
- Examination of the specimens after tests (Practice C856) to identify the products of alkali reaction
- Field service records can be used in the assessment of performance (where available)

When it has been concluded from the results of tests performed using this test method and supplementary information that a given aggregate should be considered potentially deleteriously reactive, the use of mitigative measures such as low-alkali Portland cement, mineral admixtures, or ground granulated blast-furnace slag should be evaluated. This test method permits detection, within 16 days, of the potential for deleterious alkali-silica reaction of aggregate in mortar bars.



## 7.14 FIRE RESISTANCE

The danger of fire is present always and everywhere. The imminent danger depends upon actual exposure, and naturally differs if the threatened construction is a pedestrian subway, a roadway tunnel or a subterranean garage in a skyscraper. Concrete is the load-bearing material in nearly all structures and is therefore at high risk, since the entire structure would collapse upon its material failure. Concrete must therefore, independent of the danger scenario, be properly formulated or protected by external measures, in order to hinder failure at high temperature in case of fire.



### Measures

- Aggregates of the carbonate type – limestone, dolomite, limerock, tend to perform better in a fire as they calcine. Types containing silica perform less well
- Polymer monofilament fibers (e.g. polypropylene) significantly reduce the explosive spalling effect of concrete under fire load (Common dosage 2 – 3 kg/m<sup>3</sup>)
- Sprayed lightweight mortars such as Sikacrete®-F act as a passive protection of the concrete

**Test methods e.g.** ASTM E119   ACI 216   DIN 4102   DIN 1991-1-2

The test exposes a test specimen to a standard fire controlled to achieve specified temperatures throughout a specified time period. The test provides a relative measure of the fire-test-response of comparable building elements under these fire exposure conditions. The exposure is not representative of all fire conditions because conditions vary with changes in the amount, nature and distribution of fire loading, ventilation, compartment size and configuration, and heat sink characteristics of the compartment. Variation from the test conditions or test specimen construction, such as size, materials, method of assembly, also affects the fire-test-response.

For these reasons, evaluation of the variation is required for application to construction in the field.

## Testing with design fires (temperature-time curves)

These fire exposure rating curves all simulate the temperature profile of a tunnel fire. The example of the Dutch RWS curve defines the maximum exposure which can be expected in the worst case scenario: This is defined as a fire of a road tanker truck with a load capacity of 50 m<sup>3</sup> that is 90% full of liquid hydrocarbon fuel (petrol). After 120 minutes the temperature on the reinforcement of the concrete shall not exceed 250 °C in order to pass the test procedure.

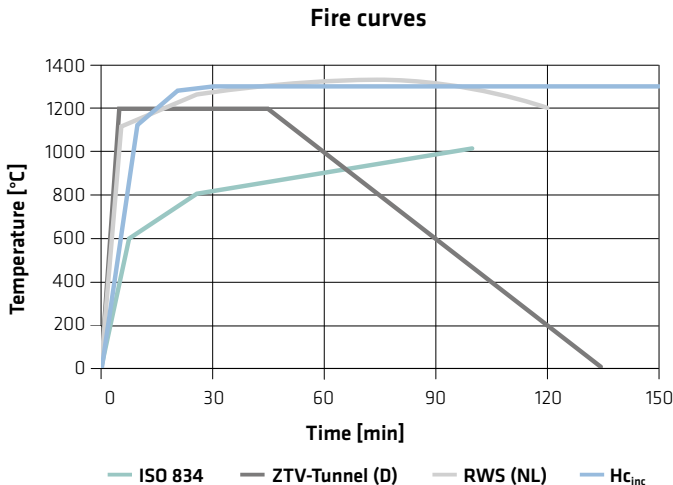

Fig. 7.14.1: Temperature-time curves of various design fires based on different regulations



## 7.15 CHLORIDE MIGRATION

One aspect of the durability of concrete and the service life of a concrete structure is dependent on the protection of the reinforcement against chloride exposure. Chloride ions migrate through the concrete mainly by diffusion, interact with the passivation layer of the steel and leading subsequently to corrosion of the steel reinforcement. Other ways of transportation of the chloride ions are capillary absorption as well as hydrostatic pressure.



### Measures

- The reduction of w/c-ratio has an impact on chloride migration  
→ reduce water/cement-ratio by adding superplasticizer like **Sika® ViscoCrete® / SikaPlast®**
- Positive influence of pozzolanic materials (e.g. micro silica fume (**SikaFume®**) and flyash)  
→ the use of pozzolans reduces chloride migration
- Positive influence of latent hydraulics (GGBFS / Ground Granulated Blast-Furnace Slag)  
→ the use of latent hydraulics reduces chloride migration significantly

### Important:

- Only the quality of the binder paste will have an influence on the chloride migration
- In order to compare results it is important to have a definition of test procedure (time to test, limits, voltage, etc.)

### Sika recommendation:

- Binder concept: 30% OPC / 5% SF / 65% GGBFS /
- W/c-ratio < 0.38
- Synthetic fibers for a further minimizing of cracks

**Test methods e.g.** NT-Build 492 ASTM C1202 SIA 262/1 Annex B

## **ASTM C1202 Standard Test Method for Electrical Indication of Concrete's Ability to Resist Chloride Ion Penetration**

This test method covers the laboratory evaluation of the electrical conductance of concrete samples to provide a rapid indication of their resistance to chloride ion penetration.

It consists of monitoring the amount of electrical current passed through 2-in. (51-mm) thick slices of 4-in. (102-mm) nominal diameter cores or cylinders during a 6-h period. A potential difference of 60 V dc is maintained across the ends of the specimen, one of which is immersed in a sodium chloride solution, the other in a sodium hydroxide solution. The total charge passed, in coulombs, has been found to be related to the resistance of the specimen to chloride ion penetration.

### **SIA 262/1 Concrete construction – additional requirements**

Chloride ions will be introduced in a water saturated sample through an electrical current. The penetration depth of the chloride ion will be measured. Based on the penetration depth, the voltage and further parameters a chloride migration coefficient will be calculated.

### **NT Build 492: Concrete, mortar and cement-based repair materials: Chloride migration coefficient from non-steady-state migration experiments**

This procedure is for determination of the chloride migration coefficient in concrete, mortar or cement-based repair materials from non-steady-state migration experiments.

The method is applicable to hardened specimens cast in the laboratory or drilled from field structures. The chloride migration coefficient determined by the method is a measure of the resistance of the tested material to chloride penetration. This non-steady-state migration coefficient cannot be directly compared with chloride diffusion coefficients obtained from the other test methods, such as the non-steady-state immersion test or the steady-state migration test.

# 8 CONCRETE TYPES

## 8.1 WATERPROOF CONCRETE

Design and construction of a watertight concrete structure is a system approach. The water impermeability of a construction is determined by fulfilment of the decisive requirements regarding limitation of water permeability through the concrete, the joints, installation parts, as well as cracks. Long lasting, durable watertight constructions are achieved by application of a well-defined, engineered system. All involved parties have to closely interact in order to minimize the probability of mistakes.



*Fig. 8.1.1: Water absorption of concrete under pressure measures the maximum water penetration in mm after a defined time with a specified pressure. (72 hours with 5 bar according EN12390-8)*

Waterproof concrete is normally an impermeable concrete. To obtain an impermeable concrete, a suitable particle-size distribution curve must be generated and the capillary porosity has to be reduced.

Measures to reduce the capillary porosity are as follows:

- Reduction of w/b-ratio
- Pore blocker to further reduce the water transport
- Shrinkage reduction (dry and plastic) to minimize crack formation
- Additional sealing of the voids with pozzolanic reactive material
- The concrete curing process is the final parameter affecting the water resistance

### Concrete Composition

#### Aggregate

- Well graded particle size distribution curve
- Fines content of the aggregate kept low (suitable range)
- Adjustment to the binder content is usually necessary to obtain a satisfactory fines content

## Cement

- Conformity with the minimum cement content according to EN 206
- Minimize paste volume as for the recommended application

## Additions

- Use of pozzolanic or latent hydraulic additions

## Water content (w/b-ratio)

- Low w/b-ratio to reduce the capillary porosity

## Placing

- A plastic to soft concrete is recommended to produce waterproof concrete
- Careful and correct compaction of the concrete is important

## Curing

- Immediate and thorough curing is essential

Impermeability of concrete against water is determined by the impermeability of the binder matrix, i.e. capillary porosity. Decisive factors for the capillary porosity are the w/b-ratio as well as the content and type of pozzolanic or latent hydraulic materials. A powerful superplasticizer is used to lower the w/b-ratio. This in turn decreases the volume of capillary pores within the concrete matrix, while maintaining high workability. These pores are the potential migratory paths for water through the concrete. With application of water resisting admixture the calcium in the cement paste produces a hydrophobic layer within the capillary pores. This consequently blocks the pores and provides effective protection even at 10 bar (100 meters head of water). The concrete should be placed, compacted, and cured in accordance with good concrete practice. The correct system for jointing (movement joints, construction joints) is the key to achieving a watertight structure. Concrete pour sequences and bay sizes need to be considered in order to reduce the risk of plastic shrinkage cracking. As a guide, an aspect ratio not exceeding 3:1 is suggested for wall pours in particular.





Fig. 8.1.2: Sika waterbars are flexible preformed PVC waterstops for the waterproofing of both movement and construction joints which can be subjected to low and high water pressure.

On the one hand, correct design of any joint is essential. On the other hand proper and careful installation of the jointing system is decisive for achieving watertightness of constructions. If watertight concrete leaks, then most often this is due to poor joint construction. In addition other details such as tie bar holes and service entries need to be considered. Depending on the level of protection against water, i.e. outside water pressure as well as intended utilization of the construction, different joint systems are available. Non-movement joints are usually sealed using hydrophilic strips which come in various shapes and sizes and swell on contact with water. Where a structure requires a higher level of protection, more advanced joint systems are available which may offer a combination of hydrophilic elements built into a resin injected hose. This provides an excellent secondary line of defense. Where movement joints are necessary, these can be sealed using a Sikadur® Combiflex® tape secured internally or externally using Sikadur® epoxy adhesives, or traditional Sika®-Waterbars.

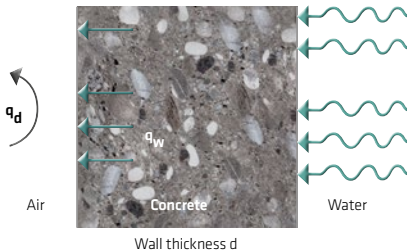

Fig. 8.1.3: Immersion and permanent water contact. The water permeability limit for watertightness is defined as  $10 \text{ g}/(\text{m}^2 \times \text{hours})$  (according to SIA 262/1), where water permeability is smaller than vaporizable volume of water without pressure over a defined period.

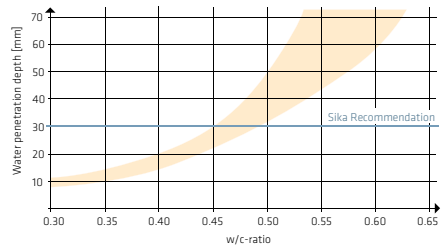

Fig. 8.1.4: Water penetration under hydrostatic pressure. The water permeability limit for watertightness is defined as a maximum water penetration into the concrete under a specific pressure over a defined period.

## Concrete mix design advice and recommended measures:

Components	Description	Example formula
Aggregates	Any quality aggregates possible	All aggregate sizes are possible
Cement	Any cement meeting local standards	350 kg/m <sup>3</sup>
Powder additives	Fly ash or ground granulated blast furnace slag	Sufficient fines content by adjustment of the binder content
Water content	Fresh water and recycling water with requirements regarding fines content	w/c-ratio according to standards with regard to exposure class < 0.45
Concrete admixture	Superplasticizer Type dependent on placement and workability time	<b>Sika® ViscoCrete®</b> or 0.60 – 1.50% <b>SikaPlast®</b> or <b>Sikament®</b>
	Water resisting admixture	<b>SikaControl® WT</b> 1.00 – 2.00%
Installation requirements and curing	Curing compound Curing that starts as early as possible and is maintained for a sufficient period of time has significant influence on plastic and drying shrinkage	Subsequent curing to ensure high quality (compactness) of surfaces <b>Sika® Antisol®</b>
Joint sealing	Sealing of movement joints, construction joints, penetrations and construction damage	<b>Sika® Waterbars</b> <b>Sikadur® Combiflex®</b> <b>Sika® Fuko System</b> <b>SikaSwell®</b>
Waterproofing systems	Flexible waterproofing membrane systems, if required with single or double compartment	<b>Sikaplan®</b> <b>SikaProof®</b>

## Sika product use

Product name	Product type	Product use
<b>Sika® ViscoCrete®</b> <b>SikaPlast®</b> <b>Sikament®</b>	Superplasticizer	Increased strength and impermeability Substantial water reduction Reduction in capillary porosity
<b>SikaControl® WT</b>	Water resisting admixture	Reduced water conductivity and improved water impermeability
	Water resisting and crystalline waterproofing concrete admixture	Reduced water conductivity and improved water impermeability Enhances the self-healing properties of the concrete
<b>Sika® Antisol®</b>	Curing agent	Protection from premature drying

## 8.2 CORROSION RESISTANT CONCRETE

Concrete is an ingenious building material, due to the possibility of the combination with reinforcing steel, thus resulting in a tremendous load-bearing capacity. The combination of steel and concrete has the advantage that under normal conditions the high pH value of concrete creates a passivating layer of iron hydroxides on the steel surface which protects it from corrosion. Particularly steel, however, can be compromised in its durability of performance by the presence of moisture and salt.



Fig. 8.2.1: Damage to concrete structure due to insufficient concrete cover and low concrete quality

### WORKING MECHANISM OF Sika® FerroGard® CORROSION INHIBITORS

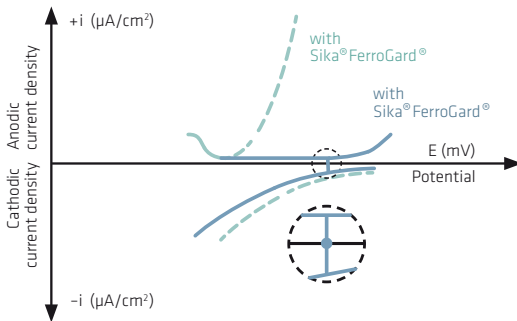

Fig. 8.2.2: Steel in the chloride-containing concrete; with and without Sika® FerroGard®

Chlorides are displaced at the steel surface by **Sika® FerroGard®-901 S**. It forms a protective film which moves the corrosion potential and reduces the current densities to a very low level.

Standard construction practices ensure that corrosion of steel reinforcements is limited. These practices include observance of minimum concrete quality (w/b-ratio, cement content, minimum strength) and minimum concrete cover of rebars. However, in many cases, especially in environments with high levels of chlorides (de-icing salts, seawater, or even contaminated concrete mix components), these basic protection procedures prove insufficient. In order to prevent corrosion or delay its start and thereby extend the life of a structure, four additional steps can be taken to protect the steel from corrosion: increase concrete quality, increase the concrete cover, utilize corrosion inhibitors and application of protective coatings. Increasing concrete quality means reduction of the number and size of capillary pores.

This increases the density of the concrete matrix and as a result hinders the transport of chlorides or  $\text{CO}_2$  into the concrete. Reduction of the w/b-ratio through application of high range water reducers or use of supplementary cementitious materials like fly ash, silica fume or natural pozzolans represent opportunities in concrete technology to improve the mix design even more.

When choosing improved concrete quality for protection against corrosion, extra attention must be given to proper placement, curing of concrete and shrinkage potential of the concrete mix, as small cracks can allow chlorides or  $\text{CO}_2$  to penetrate to the reinforcing steel regardless of the density of the concrete mix. Corrosion inhibitors are added to the concrete mix during the batching process. Inhibitors do not significantly influence the density of concrete or impact the ingress of chlorides or  $\text{CO}_2$ , but act directly on the corrosion process. Corrosion inhibitors are defined in a number of ways. On one hand as an admixture which will extend the time before corrosion initiates, and on the other hand an admixture which reduces the corrosion rate of the embedded steel in concrete containing chlorides.

Therefore a corrosion inhibitor must reduce the corrosion rate and the corroded area of rebars in concrete containing chlorides. The main products used as corrosion inhibitors today are either calcium nitrite based products or aminoester organic corrosion inhibitors. Protective coatings are used to reduce the ingress of chlorides or carbon dioxide. Coatings can be applied according to two basic options, either to the surface of the concrete or to the steel rebars themselves before they are embedded in the concrete.





## Long-term field results

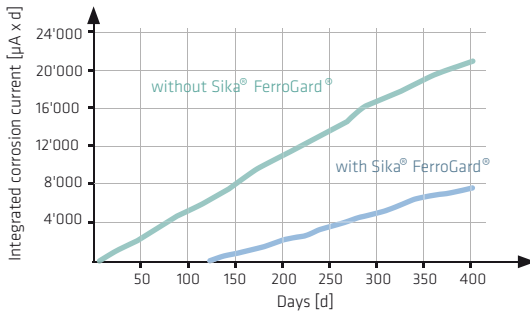

Fig. 8.2.3: The Sika Research Department in Zurich tested the anticorrosive effect of Sika® FerroGard® on cracked concrete beams. The specimens were produced in accordance with ASTM G 109 and were cyclically treated with road salts. Periodic measurement of the corrosion current confirms the protective effect of Sika® FerroGard®.

Three reinforced concrete elements were placed next to a busy arterial highway in Switzerland. The walls have been exposed for more than 22 years to real-life conditions including de-icing-salt-bearing splash water in winter. One of the concrete elements contains Sika® FerroGard®-901 corrosion inhibiting concrete admixture with a dosage of 12 kg/m<sup>3</sup> one with silica fume and another element without. The main conclusions of this long-term investigation.

- The reference concrete steel corrosion initiated after approximately 8 – 9 years
- The Sika admixed organic corrosion inhibitor delayed chloride induced corrosion for approximately 22 years
- Under these conditions the corrosion inhibitor increased the time to corrosion initiation by a factor of approximately 3

Fig. 8.2.4: Potential measurement on a retaining wall along a road with heavy traffic with high use of de-icing salt, after less than 10 years of exposure. The darker the coloration, the higher the potential for corrosion.



## Surface Applied Corrosion Inhibitor for Reinforced Concrete

**Sika® FerroGard® can also be applied on the surface**, designed for use as an impregnation on hardened reinforced concrete.

**Sika® FerroGard®-903 Plus** is a multifunctional inhibitor which controls the cathodic and anodic reactions. This dual action effect significantly retards both the onset and the rate of corrosion and increases the time to future maintenance.

**Sika® FerroGard®-903 Plus** is normally applied as part of a corrosion management strategy. It is a component of all the Sika concrete repair and protection systems.



## Concrete mix design advice and recommended measures:

Components	Description	Example formula
Aggregates	Any quality aggregates possible	All aggregate sizes are possible
Cement	Any cement meeting local standards	Target cement paste volume as low as possible for the respective placing method
Powder additives	Fly ash, ground granulated blast furnace slag, silica fume, natural pozzolanes	
Water content	Fresh water and recycling water with requirements regarding fines content	w/c-ratio according to standards with regard to exposure class < 0.46
Concrete admixture	Superplasticizer Type dependent on placement and early strength requirements  Corrosion inhibitor	<b>Sika® ViscoCrete®</b> or <b>SikaPlast®</b> or <b>Sikament®</b> 0.60 - 1.50%  <b>Sika® FerroGard®-901 S</b> 10 - 12 kg/m <sup>3</sup> <b>Sika® CNI</b> 13 - 40 kg/m <sup>3</sup>
Installation requirements and curing	Curing compound Curing that starts as early as possible and is maintained for a sufficient period of time has significant influence on plastic and drying shrinkage	Careful installation and compaction. Subsequent curing to ensure high quality (compactness) of surfaces <b>Sika® Antisol®</b>
Protective system	Surface protection against ingress of chlorides and carbon dioxide	Sika offers a wide range of rigid and flexible solutions to prevent the penetration of water. Sika Solution: <b>Sikagard®</b>

## Sika product use

Product name	Product type	Product use
<b>Sika® ViscoCrete®</b> <b>SikaPlast®</b> <b>Sikament®</b>	Superplasticizer	Water reduction, increased strength and impermeability with guaranteed consistence (workability) and pumpability
<b>Sika® Ferrogard®</b> <b>Sika® CNI</b>	Corrosion inhibitor	Protects the surface of steel reinforcement and reduces the rate of corrosion
<b>SikaFume®</b>	Silica fume	High strength, increased impermeability and improved sulfate resistance
<b>SikaControl® AER</b>	Air-entrainer	Air-entrainment Interruption of capillary voids Reduction of water absorption
<b>Sika® Antisol®</b>	Curing agent	Protection from premature drying

## 8.3 FROST AND FREEZE / THAW RESISTANT CONCRETE

De-icing salt attacks concrete surfaces, one of the most damaging strains for concrete structures, though underestimated for decades also due to the periodically extreme quantities of de-icing salt applied. Through appropriate structural technique and observance of basic technological measures pertinent to concrete, the building material can demonstrate permanently high resistance to frost and to the strain which de-icing salt represent.

Frost and freeze / thaw resistant concrete must always be used when concrete surfaces are exposed to weather (wet) and the surface temperature can fall freezing.

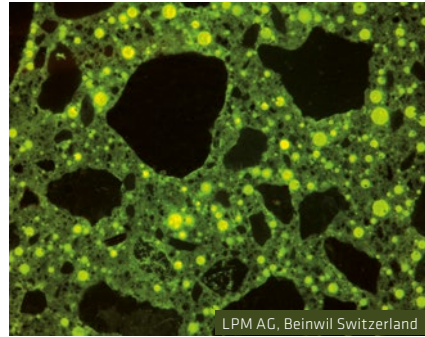

*Fig. 8.3.1: Artificially introduced air voids, caused by an air-entrainer, generate space for expansion in the concrete structure to allow for the roughly 10% increase in volume when water freezes to become ice.*

By adding air-entrainers, small spherical air voids are generated during the mixing process in the binder paste (cement, SCM, water) of the concrete. The aim is to ensure that the hardened concrete is frost and freeze / thaw resistant (by creating room for expansion of any water during freezing conditions).

### **Design of air-entrained concrete**

Detailed specifications for strength, air content and test methods must be given. For major projects preliminary test should be carried out under actual conditions. During the concreting works check the air content at the concrete plant and before placing.

---

Characteristics of air voids

Shape: spherical  
Size: 0.02 to 0.30 mm  
Spacing factors:  
≤ 0.20 mm frost resistant  
≤ 0.15 mm freeze / thaw resistant

---

Positive secondary effects

Improvement in workability  
Disrupting of capillary pores  
(water resistant)  
Better cohesion of the fresh concrete

---

Negative effects

Reduction in mechanical strengths  
(compressive strength)

---

## The factors influencing air-entrainment

### ■ Granulometry

The air voids are mainly formed around the 0.25 – 0.50 mm sand fraction. Larger particles have no effect on the air-entrainment. Ultrafines from the sand constituents or the cement and some admixtures can inhibit air-entrainment.

### ■ Consistence

Optimum air-entrainment is achieved in the plastic to soft plastic range. A concrete that is softened by the addition of extra water might not retain the air voids as well or as long as the original concrete.

### ■ Temperature

The air-entrainment capability decreases as fresh concrete temperatures rise and vice versa.

### ■ Delivery

A change in the air content can be expected during delivery. Dependent on the method of delivery and the vibration during the journey, mixing or demixing processes take place in the concrete. Air-entrained concrete must be mixed again before installation and the air content is only then to be measured.

### ■ Compaction of air-entrained concrete

Concrete vibration mainly removes the air 'entrapped' during placing, including the coarse voids in the concrete. Pronounced overvibration can also reduce the 'entrained' air by 10 to 30%. Concrete susceptible to segregation can then lose almost all of the air voids or exhibit foaming on the surface.

### ■ Fines replacement

1% of entrained air can replace approximately 10 kg of fines ( $< 0.125$  mm) per  $m^3$  of concrete. Air voids can improve the workability of rough, low-fines mixes.



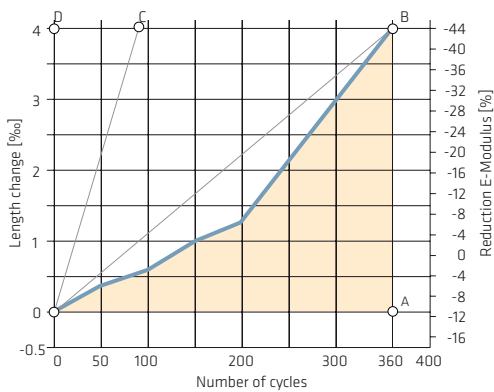

Resistance range	Definition
AOB	high (WF-L > 80%)
BOC	middle (WF-L = 80 - 25%)
COD	low (WF-L < 25%)

Rating: High WF-L = 94%

Fig. 8.3.2: In test BE II according to D-R 400, the test prisms are subject to alternating loads between +20 °C and -20 °C, the change in length is measured and judged between three ranges of durability (low / middle / high). Calculation according to ASTM C666.

### Type, size and distribution of air voids

Air voids contained in a standard concrete are generally too large (> 0.3 mm) to increase the frost and freeze / thaw resistance. Effective air voids are introduced through special air-entrainers. The air voids are generated physically during the mixing period. To develop their full effect, they must not be too far from each other. The 'effective spacing' is defined by the so-called **spacing factor SF**.

### Production / mixing time

To ensure high frost and freeze / thaw resistance, the wet mixing time must be longer than for a standard concrete and continue after the air-entrainer is added. Increasing the mixing time from 60 to 90 seconds improves the content of quality air voids by up to 100%.

### Quality of air voids required

To obtain high frost resistance, the cement matrix must contain about 15% of suitable air voids and about 20% for high freeze / thaw resistance. Long experience confirms that there are enough effective air voids in a concrete if the result of the test (air pot) show the following air contents:

- Concrete with 32 mm maximum particle size: 3% to 5%
- Concrete with 16 mm maximum particle size: 4% to 6%

Fresh concrete with an air void content of 7% or over should only be installed after detailed investigation and testing.



Fig. 8.3.3: Scattered de-icing agent considerably intensifies the reaction upon freezing of water and leads to substantially greater damage in areas of concrete close to the surface.

### Concrete mix design advice and recommended measures:

Components	Description	Example formula
Aggregates	Aggregates employed must be frost-resistant	All aggregate sizes are possible
Cement	Any cement meeting local standards Pure Portland cement for highest resistance	Target cement paste volume as low as possible for the respective placing method
Powder additives	For increased density	<b>SikaFume®</b> up to max. 4%
Water content	Clean mixing water, free of fines	w/c-ratio according to standards with regard to exposure class < 0.46
Concrete admixture	Superplasticizer Dosing dependent on formula; superplasticizer and air-entrainer must be adapted to each other  Air-entrainer (mixing time min. 90 sec.) Required quantity of air entrainer is highly dependent on cement and the fines portion in sand	<b>Sika® ViscoCrete®</b> or <b>SikaPlast®</b> or <b>Sikament®</b> 0.60 – 1.40%  <b>SikaControl® AER</b> dosing: Air void content with – max. particle diam. 32 mm approx. 3 – 5% – max. particle diam. 16 mm approx. 4 – 6%
Installation requirements and curing	Curing compound Frost resistant concrete should only be transported in ready-mix trucks, and should be mixed again thoroughly (approx. 30 sec./m <sup>3</sup> ) before unloading. Standard air void measurement should follow	Careful installation and compaction. Subsequent curing to ensure high quality (compactness) of surfaces <b>Sika® Antisol®</b>

### Sika product use

Product name	Product type	Product use
<b>Sika® ViscoCrete®</b> <b>SikaPlast®</b> <b>Sikament®</b>	Superplasticizer	Reduction of w/c-ratio to reduce capillary porosity
<b>SikaControl® AER</b>	Air-entrainer	Air-entrainment to ensure frost and freeze / thaw resistance
<b>SikaFume®</b>	Silica fume	For further density of the hardened cement paste and improvement of the bond between aggregate and hardened cement paste
<b>Sika® Antisol®</b>	Curing agent	Protection from premature drying
<b>SikaControl® AER-200 P</b>	Air-entrainer	Chemical working air-entrainment to ensure frost and freeze / thaw resistance

## 8.4 SULFATE RESISTANT CONCRETE

Particularly in underground construction, concrete structures are exposed to influences emerging from the sub grade such as permanent mechanical stresses and aggressive water. Concrete is nevertheless characterized by its outstanding durability. Solutions containing sulfates, such as in natural or polluted groundwater, represent a considerable deteriorating impact on concrete. This can eventually lead to loss of strength, expansion, spalling of surface layers and ultimately to disintegration.



*Fig. 8.4.1: Concrete deterioration due to sulfate attack shows a strong increase in length because of the spalling attack. First cracks have appeared in sample.*

The intended life cycle of a concrete structure is ensured by a suitable concrete mix design that is based on the expected exposition and various impacts. Sulfate contained in water reacts with the hydrates of the tricalcium aluminate (mainly AFm) in the cement to form ettringite (also thaumasite under certain conditions), which leads to increases in volume. This volume increase results in high internal pressure in the concrete structure which induces cracking and spalling. Such attack is classified among types of chemical attack under which standard concrete designed without dedicated measures can experience significant damages. Field experience demonstrates that loss of adhesion and strength are usually more severe than concrete damage resulting from expansion and cracking.

Sulfate resistance of concrete is determined by the sulfate resistance of the cement matrix as well as its ability to withstand diffusion of sulfate ions through the matrix. Concrete intended to be sulfate-resistant should therefore be characterized by high impermeability as well as higher compressive strength. Furthermore cements with low  $C_3A$  and  $Al_2O_3$  content should be used. Doing so reduces the potential for any deteriorating reactions. In addition the inclusion of silica fume is favorable, since this contributes to higher density of the cement matrix in conjunction with enhanced bonding between the cement matrix and aggregates, and thus leading to higher compressive strength.

Sulfate attack is designated as exposure class chemical attack according to EN 206. Therefore the exposure class is determined by the expected sulfate content in the water contacting the concrete. Depending on the exposure class, a minimum cement content in combination with a maximum w/c-ratio is required, as well as a mandatory utilization of cement with high sulfate resistance.

In tunneling, durability is of decisive importance and sulfate attack is a constantly occurring and challenging phenomenon. This is especially true in the case of production of pre-cast tunnel lining segments for tunnel boring machine (TBM) and rock support applied by sprayed concrete. In excavations in which high sulfate attack is anticipated, it is difficult to fulfill all technical requirements unless appropriate measures regarding the concrete mix design are also taken.





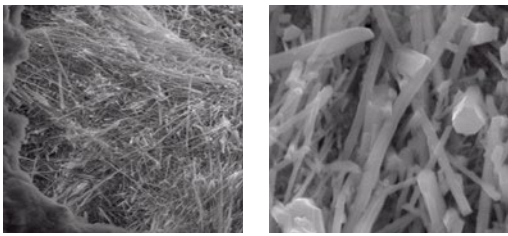

*Fig. 8.4.2: Classic form of sulfate attack associated with ettringite or gypsum formation. Flurry of ettringite rods grown in mature cement pastes subjected to external sulfate solutions.*

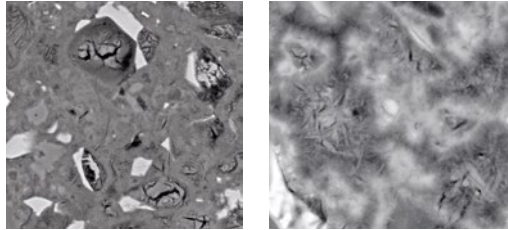

*Fig. 8.4.3: Ettringite cores forming into aged cement pastes. Right picture is a 2 years old paste subjected to sulfate attack. One clearly sees the ettringite cores forming within the C-S-H.*

For sprayed concrete the use of alkali free accelerators is mandatory to achieve adequate sulfate resistance. The industrialized, swift production of tunnel lining segments requires production cycles of only a few hours, with a maximum temperature development of 60 °C in the concrete. This is very difficult with conventional sulfate resistant cements, due to the fact that these cements exhibit slow strength development. A concrete mix containing silica fume and a superplasticizer fulfills both criteria, productivity and sulfate resistance, but this system is very sensitive to proper curing due to crack formation. With the application of a water-based epoxy emulsion immediately after formwork release of the segments, micro-crack free concrete can be produced.



*Fig. 8.4.4: Immediately following curing in a steam channel, the concrete surface of tunnel lining segments is coated with water-based epoxy emulsion that is absorbed even into the smallest pores, thereby generating a sealed, protective coating.*

## Concrete mix design advice and recommended measures:

Components	Description	Example formula
Aggregates	Any quality aggregates possible	All aggregate sizes are possible
Cement	Compliance with EN 206 with moderate to high sulfate resistance ASTM C150 sulfate resistant cements	Target cement paste volume as low as possible for the respective placing method
Powder additives	Fly ash, ground granulated blast furnace slag, silica fume, natural pozzolans	<b>SikaFume®</b> 4 – 8%
Water content	Compliance with EN 206, depending on exposure class  Compliance with ASTM, depending on exposure class	Exposure class w/c-ratio XA 1 < 0.55 XA 2 < 0.50 XA 3 < 0.45 Moderate Typ 2 < 0.50 Severe Typ 5 < 0.45 Very severe Typ 5 < 0.40
Concrete admixture	Superplasticizer Type dependent on placement and early strength requirements	<b>Sika® ViscoCrete®</b> or 0.60 – 1.50% <b>SikaPlast®</b> or <b>Sikament®</b>
Installation requirements and curing	Curing compound Curing that starts as early as possible and is maintained for a sufficient period of time has significant influence on plastic and drying shrinkage	Careful installation and compaction. Subsequent curing to ensure high quality (compactness) of surfaces <b>Sika® Antisol®</b>
Protective system / Special curing system	Concrete resistance to chemicals is highly limited. Appropriate coatings can durably protect the concrete surface against sulfate exposure	Special curing of precast tunnel segments immediately after demolding with <b>Sikagard®</b>

## Sika product use

Product name	Product type	Product use
<b>Sika® ViscoCrete®</b> <b>SikaPlast®</b> <b>Sikament®</b>	Superplasticizer	Substantial water reduction Improvement in placing (workability and compaction)
<b>SikaFume®</b>	Silica fume	Reduced permeability
<b>Sika® Antisol®</b>	Curing agent	Protection from premature drying

## 8.5 FIRE RESISTANT CONCRETE

The danger of fire is present always and everywhere. The imminent danger depends upon actual exposure, and naturally differs if the threatened construction is a pedestrian subway, a roadway tunnel or a subterranean garage in a skyscraper. Concrete is the load-bearing material in nearly all structures and is therefore at high risk, since the entire structure would collapse upon its material failure. Concrete must therefore, independent of the danger scenario, be properly formulated or protected by external measures, in order to hinder failure at high temperature in case of fire.



*Fig. 8.5.1: In special furnace chambers fire trajectories can be replicated, panels tested and subsequently evaluated. Temperature development is measured and recorded at various depths.*

### **Concrete with high fire resistance is used for**

- Emergency areas in enclosed structures (tunnel emergency exits)
- General improved fire resistance for infrastructure
- Fire resistant cladding for structural members

### **Production of concrete with high fire resistance**

- The concrete production does not differ from standard concrete
- The mixing process must be monitored due to the fibers normally included
- It is beneficial to the future fire resistance of the concrete if it can dry out as much as possible

### **Constituents for the production of concrete with high fire resistance**

- Achievement of maximum fire resistance is based on the composition of the aggregates used
- The resistance can be greatly increased by using special aggregates
- The use of special plastic fibers (PP) increases the resistance considerably
- The use of selected sands improves the resistance of the cement matrix

## Behavior of concrete under fire load

The capillary and interstitial water begins to evaporate at temperatures around the boiling point of water (100 °C). Steam needs more space and therefore exerts expansion pressure on the concrete structure. The cement matrix begins to change at temperatures of about 700 °C. The effect of the aggregates is mainly dependent on their origin and begins at about 600 °C.

Fire resistance is defined as the ability of a structure to fulfill its required functions (load bearing function and /or separating function) for a specified fire exposure and a specified period (integrity).

Fire resistance applies to building elements and not the material itself, but the properties of the material affect the performance of the element of which it forms a part. In most cases fire temperature increases rapidly in minutes, leading to the onset of explosive spalling as the moisture inherent in the concrete converts to steam and expands.

The most severe fire scenario modeled is the RWS fire curve from the Netherlands and represents a very large hydrocarbon fire inside a tunnel (see chapter 7.14).

There are various options available to improve the fire resistance of concrete. Most concretes contain either Portland cement or Portland blended cement which begins to degrade in respect to important properties above 300 °C and starts to lose structural performance above 600 °C.

Of course the depth of the weakened concrete zone can range from a few millimeters to many centimeters depending on the duration of the fire and the peak temperatures experienced. High alumina cement used to protect refractory linings reaching temperatures of 1'600 °C has the best possible performance in a fire and provides excellent performance above 1'000 °C.



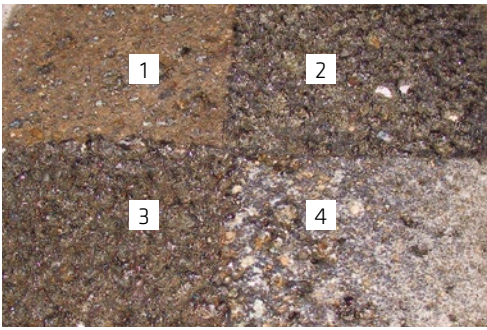

Fig. 8.5.2: Fire exposure trials for concrete containing various aggregates. Surface spalling and sintering, and a range of temperature developments at differing depths can thereby be compared.

- 1 No spalling, fused surface
- 2 Limestone; spalling 17 mm, disintegration after cooling + humidity absorption
- 3 Limestone; spalling 14 mm, disintegration after cooling + humidity absorption
- 4 Granite; spalling 25 mm, fused surface

The choice of aggregate will influence the thermal stresses that develop during the heating of a concrete structure to a large extent. Aggregates of the carbonate type such as limestone, dolomite or limerock tend to perform better in a fire as they calcine when heated, liberating CO<sub>2</sub>.

This process requires heat, so the reaction absorbs some of the fire's exothermic energy. Aggregates containing silica tend to behave less well in a fire. Finally as the heat performance is related to the thermal conductivity of the concrete, the use of lightweight aggregates can, under certain conditions, enhance the fire performance of the concrete.

Polymer monofilament fibers (e.g. polypropylene) can significantly contribute to the reduction of explosive spalling and thus improve the 'fire resistance' of the concrete. In a fire, these fibers melt at around 160 °C, creating channels which allow the resulting water vapor to escape, minimizing pore pressures and the risk of spalling.

Under conditions in which the risk of structural collapse is unacceptable, designers examine other ways to protect the concrete from the effects of fire. Alternatives range from local thickening of the concrete, cladding using heat shields coated with intumescent paint, use of protective board systems and spray-applied lightweight mortars. The purpose of these passive fire protection systems depends on the type of tunnel as well as the form being protected.

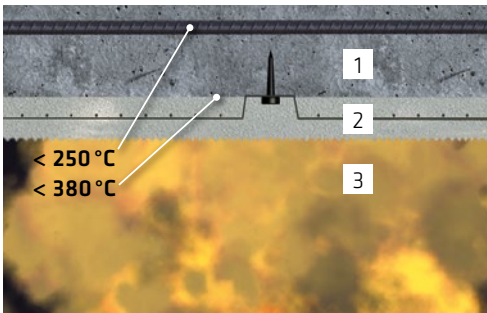

Fig. 6.5.3: Passive fire protection systems should meet the following requirements: The concrete temperature during the fire exposure shall not exceed 380 °C and the steel reinforcement temperatures shall remain under 250 °C while fire exposure.

- 1 Structural concrete
- 2 Fire protection mortar
- 3 Fire load

## Concrete mix design advice and recommended measures:

Components	Description	Example formula
Aggregates	Aggregates of the carbonate type – limestone, dolomite, limerock, tend to perform better in a fire as calcine. Types containing silica perform less well.	All aggregate sizes are possible
Cement	Any cement meeting local standards	Target cement paste volume as low as possible for the respective placing method
Water content	Fresh water and recycling water with requirements regarding fines content	w/c-ratio according to standards with regard to exposure class < 0.48
Concrete admixture	Superplasticizer Type dependent on placement and early strength requirements	<b>Sika® ViscoCrete®</b> or 0.60 – 1.50% <b>SikaPlast®</b> or <b>Sikament®</b>
	Polymer or polypropylene monofilament fibers Steel fibers	<b>SikaFiber® (PP)</b> 2 – 3 kg/m <sup>3</sup> <b>SikaFiber® (Steel)</b> 10 – 30 kg/m <sup>3</sup>
Installation requirements and curing	Curing compound Curing that starts as early as possible and is maintained for a sufficient period of time has significant influence on plastic and drying shrinkage	Careful installation and compaction. Subsequent curing to ensure high quality (compactness) of surfaces <b>Sika® Antisol®</b>
Protective system / Special curing system	Sprayed-applied lightweight mortars	<b>Sikacrete®-F</b> 25 – 40 mm

## Sika product use

Product name	Product type	Product use
<b>Sika® ViscoCrete®</b> <b>SikaPlast®</b> <b>Sikament®</b>	Superplasticizer	Due to the substantial water reduction, there is less excess water in the concrete
<b>SikaFiber®</b>	Polypropylene fibers	To strongly increase fire resistance of cementitious material
	Steel fibers	To increase mechanical properties of concrete by increasing impact strength and flexural strength

## 8.6 ALKALI-SILICA-REACTION RESISTANT CONCRETE

Aggregates constitute a major portion of concrete. Their influence on the fresh and hardened concrete is considerable. Sources of high quality aggregates are gradually dwindling in number, as a result of which the building and construction materials industry and builders of major infrastructure projects seek solutions for the use of aggregates with lower quality. The Alkali-Silica-Reaction (ASR), which can occur with aggregates, presents a particular challenge and can affect the durability of concrete.

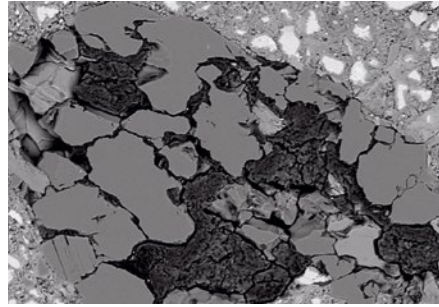

*Fig. 8.6.1: Amorphous silica spots within the aggregate have reacted with alkali ions and formed a gel that expanded upon ingress of water. The aggregate has subsequently swelled and cracked while the amorphous region (black cracked masses) expanded.*

Major infrastructure projects such as dams, roadways or airport runways require enormous quantities of aggregates, sought in closest proximity to construction sites. Some aggregates can exhibit an increased or high risk of ASR. Alkali-Silica-Reaction is a chemical reaction which occurs between the amorphous silica in the aggregate and the pore solution (alkalis) of the cement matrix. The reaction results in an increase of concrete volume, causing cracking and spalling when the generated forces exceed the tensile strength of the concrete. Essential conditions for occurrence of ASR are moisture within the concrete, a high alkaline content in the pore solution and reactive aggregates. Selection of the correct concrete mix design is critical for avoidance of ASR. Choice of the right solutions can prevent damages resulting from ASR even if highly reactive aggregates are used.

Cement clinker contributes the greatest proportion of alkaline material. The higher the cement content is, the more alkaline the mix will be. Blended cements introduce a lower alkaline content. A low w/c-ratio is considered the central factor for achievement of dense, watertight concrete. Dense concrete slows the diffusion of free alkalines and the migration of water to aggregates. For ASR to occur it requires aggregates particularly sensitive to alkalines, such as siliceous limestone, sandy limestone, limestone, gneisses and strongly deformed quartzite. Porous, cracked, weathered or crushed aggregates are more reactive than those with dense structure and round surfaces.



Pozzolanic additives such as fly ash, granulated blast furnace slag or silica fume react with and consume hydroxyl ions during hydration. This reaction lowers the pH value of the pore solution, suppressing the occurrence of ASR. Pozzolanic additives differ in shape and reactivity depending on their source, but generally their effect is more homogeneous if added to the cement grinding process as opposed to the concrete mix. There remains however some dispute regarding the efficiency of additives in lowering the speed of ASR.

Admixtures such as traditional accelerators for shotcrete may introduce considerable quantities of alkali ions and greatly increase the reactivity of the pore solution. In case of aggregates considered sensitive, alkali free accelerator should be used.

Experience has shown that inclusion of special admixtures can hem the ASR reaction, thus preventing expansion. A further possible solution is proposed with the addition of an air-entraining agent to create artificial expansion room (air voids) for the reaction products. If the possible occurrence of ASR represents a major concern, reaction trials are suggested to define the ASR potential.

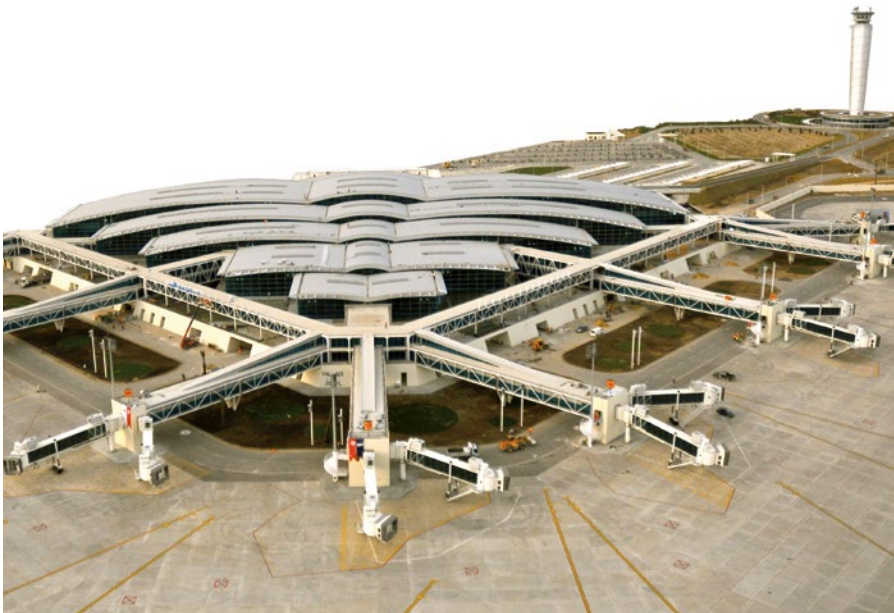





Fig. 8.6.2: The increase in volume due to the strain resulting from ASR becomes perceptible by measurement of a change in length of test specimens. Ordinarily the specimens are stored under intensified conditions (temperature, humidity, applied load) in order to accelerate the reaction.



Fig. 8.6.3: The appearance of ASR damage can be assessed very well on the drying concrete surface of this bridge pylon. Damage can appear within years or only after decades.

### The measures are:

- Partial replacement of the Portland cement by slag or other additions (Silica fume / fly ash) with low equivalent  $\text{Na}_2\text{O}$
- Analysis of the AAR/ASR potential of the aggregate and its classification (petrographic analyses / microbar test / performance testing etc.)
- Replacement or partial replacement of the critical aggregates (blending of available aggregates)
- Keep moisture access to the concrete low or prevent it (seal / divert)
- Reinforcement design for good crack distribution in the concrete (i.e. very fine cracks only)
- Impermeable concrete design to minimize the penetration of moisture



Fig. 8.6.4: Damage is often only visible after decades. Precise clarification of risk is therefore necessary in order to estimate the potential of aggregates for ASR damage reliably.

## Concrete mix design advice and recommended measures:

Components	Description	Example formula
Aggregates	The ASR potential of aggregates should be previously determined	All aggregate sizes are possible
Cement	Preferably cements with ground granulated blast furnace slag or fly ash content	Target cement paste volume as low as possible for the respective placing method
Powder additives	Silica fume, fly ash or ground granulated blast furnace slag	<b>SikaFume®</b> 3% – 6%
Water content	Clean mixing water, free of fines	w/c-ratio according to standards with regard to exposure class < 0.48
Concrete admixture	Superplasticizer Type dependent on placement and early strength requirements  Special admixtures limiting ASR	<b>Sika® ViscoCrete®</b> or 0.60 – 1.20% <b>SikaPlast®</b> or <b>Sikament®</b>  <b>SikaControl® ASR</b> 2 – 10 kg/m <sup>3</sup>
Installation requirements and curing	Curing compound Curing that starts as early as possible and is maintained for a sufficient period of time has significant influence on plastic and drying shrinkage	Careful installation and compaction. Subsequent curing to ensure high quality (compactness) of surfaces <b>Sika® Antisol®</b>
Protective system / Special curing system	Beside free alkalines and reactive aggregates, the concrete must contain moisture for ASR to occur. If a structure is exposed to water the concrete surface needs to be protected	Sika offers a wide range of rigid and flexible solutions to prevent the penetration of water. Sika Solution: <b>Sikagard®</b> , <b>SikaPlan®</b>

## Sika product use

Product name	Product type	Product use
<b>Sika® ViscoCrete®</b> <b>SikaPlast®</b> <b>Sikament®</b>	Superplasticizer	Substantial water reduction Improvement in placing (workability and compaction)
<b>SikaFume®</b>	Silica fume	Reduced permeability
<b>SikaControl® ASR</b>	Admixture to control Alkali-Silica-Reaction in concrete	Minimizes deleterious expansions in concrete due to ASR
<b>Sika® Antisol®</b>	Curing agent	Protection from premature drying

## 8.7 ABRASION RESISTANT CONCRETE

Awe-inspiring gorges and valleys are nature's testimony to the undeniable strength of water. In hydraulic engineering and in traffic zones with high loads or hard rolling bodies, concrete surfaces experience considerable and at times extremely abrasive forces. The mechanisms of damage thereby depend mainly on the type of abrasion. Whether the surface is exposed to rolling, rubbing or percussive influences differentiates the possible patterns of damage as well as the preventive measures.



*Fig. 8.71: Particularly in whitewater, concrete surfaces are subject to massive additional strains by rubble, sharp edges and abrasion, as well as possible temperature stresses due to frost exposure.*

Over the course of decades and even centuries, exposure to abrasion can yield the most varied experiences with damage patterns. Above all the difference between rolling loads in roadway traffic, heavy traffic including steel wheels or exposure to water, with or without the additional transport of sediment, must be considered. In traffic zones the intensity, weight and the type of wheels are decisive for the overall load. In the case of abrasion by water, it is the velocity of flow, the quantity and type of sediment that are crucial.

In order to boost concrete's abrasion resistance, in most cases provision for hard surfaces is the best approach. If, however, the exposure involves vibration or dynamic impact, then in addition, the adsorptive capacity of the surface plays a role. The most critical principle in the concept is the expert installation of the concrete preventing of the fines rising to the surface due to excessive vibration, and excellent curing. The desired concrete properties can emerge above all in areas close to the surface. Furthermore, the surface should offer the lowest resistance possible to abrasive attack. Surfaces that are designed as level as possible provide the smallest potential for attack.

Ascertaining damage patterns is straightforward, and is carried out by assessing the abrasion of the surface, the condition of the cement laitance skin and of aggregates near to the surface.

Concrete with enhanced or high abrasion resistance should demonstrate a target compressive strength of approximately 50 MPa. The surface can be considerably enhanced against grinding abrasion through the use of micro silica and/or surface hardener scattered on the surface. In order to boost resistance against percussive or striking impact, the toughness and flexural strength of the concrete must be improved. This can be achieved with the use of fiber reinforcements in the mix. Improving the general working capacity of concrete can be accomplished by mixing in synthetic polymers to strengthen the hardened cement paste, which furthermore enhances adhesion with aggregates. Finally there must be additional differentiation between transport distances and areas that are built to facilitate the dissipation of energy. In these areas, the use of high strength, steel fiber reinforced concrete with a strength above 80 MPa and corresponding flexural strength is recommended.

In construction the design of edges must be given particular attention. Whether this concerns dilatation joints in roadway surfaces or tearing edges in hydraulic construction, these must usually be handled specially; construction in concrete alone is normally insufficient. Special joint profiles must be incorporated, often made of steel.





*Fig. 8.7.2: Concrete roadways and other publicly accessible areas, especially those experiencing high volumes of traffic or concentrated loads, are subject to high mechanical loads and strong abrasion, often resulting in the risk of a smooth, slick surface.*



*Fig. 8.7.3: Industrial flooring surfaces also experience strong abrasion due to constantly rolling and dynamic loads in the same places. Hard concrete coatings and special dispersants can enhance the grip and minimize wear.*

### **Conditions for better abrasion resistance**

The abrasion resistance of the hydrated cement is lower than that of the aggregate, particularly with a porous cement matrix (high water content). However, as the w/c-ratio decreases, the porosity of the hydrated cement decreases and the bond with the aggregate improves.

### **Curing**

- With Sika® Antisol® (remove mechanically afterwards, i.e. by wire brushing or blast cleaning if a coating is to follow), cover with sheeting to cure, preferably for several days.



*Fig. 8.7.4: Due to continuous exposure, the cement film is eroded in an initial step, and thereafter the aggregates can be rubbed, knocked or washed out of the hardened cement paste.*

## Concrete mix design advice and recommended measures:

Components	Description	Example formula
Aggregates	Aggregates employed must be as hard as possible	All aggregate sizes are possible
Cement	Any cement meeting local standards	Target cement paste volume as low as possible for the respective placing method
Powder additives	Silica fume for enhanced compactness	<b>SikaFume®</b> up to max. 8%
Water content	Clean mixing water, free of fines	w/c-ratio according to standards with regard to exposure class < 0.45
Concrete admixture	Superplasticizer Type dependent on placement and early strength requirements  PP Fibers (micro) PP Fibers (macro) Steel fibers	<b>Sika® ViscoCrete®</b> or 0.60 - 1.20% <b>SikaPlast®</b> or <b>Sikament®</b>  <b>SikaFiber®</b> Micro PP 0.6 - 1.0 kg/m <sup>3</sup> Macro PP 3 - 6 kg/m <sup>3</sup> Steel 10 - 30 kg/m <sup>3</sup>
Installation requirements and curing	Curing compound Curing that starts as early as possible and is maintained for a sufficient period of time has significant influence on plastic and drying shrinkage	Careful installation and compaction. Subsequent curing to ensure high quality (full compaction) of surfaces <b>Sika® Antisol®</b>
Surface coating	Scattering material for surface hardening Protective coating	<b>Sikalfloor®</b> 0.3 - 9 mm

## Sika product use

Product name	Product type	Product use
<b>Sika® ViscoCrete®</b> <b>SikaPlast®</b> <b>Sikament®</b>	Superplasticizer	Substantial water reduction Improvement in placing (workability and compaction)
<b>SikaFume®</b>	Silica fume	Reduced permeability
<b>SikaFiber®</b>	Steel fibers PP Fibers (micro and macro)	Increased impact and abrasion resistance Reduce shrinkage characteristics
<b>Sika® Antisol®</b>	Curing agent	Protection from premature drying

## 8.8 CHEMICAL RESISTANT CONCRETE

Water is the source of all life as well as a scarce commodity. Clean drinking water should therefore be protected against contamination, while wastewater must be treated before being released into a discharge system. The wastewater itself as well as the treatment measures undertaken represent an exposure to chemicals for concrete surfaces. Through sensible planning and proper concrete design concepts, the surfaces can be designed for durability. Concrete's resistance to chemical attack is nevertheless limited, therefore surface protection systems must be considered in case of heavy exposure.



*Fig. 8.8.1: Heavy leaching and damage to the structural concrete are observed particularly in the water splash zone of biological treatment basins.*

Chemical resistance in this case signifies resistance to corrosion and erosion of concrete. Alongside known types of spalling attack such as frost (with and without de-icing agents), ASR (Alkali-Silicate-Reaction), sulfate exposure and mechanical surface abrasion, in wastewater treatment facilities particularly, chemical and solvent aggression is also prevalent. The water treated in such facilities, however, varies too greatly to describe the attack on concrete surfaces as uniform. Decisive in addition to the general quality of the water is also its hardness ( $^{\circ}\text{fh}$  or  $^{\circ}\text{dH}$ ).

On one hand the surface of the concrete is attacked by a cocktail of chemicals, while on the other mechanical stress (e.g. high pressure cleaning) also occurs at the surface. Thereby fines are washed out that have already been dissolved but remained adhered within the concrete structure. This entire process is additionally accelerated by softened water (hardness  $< 15^{\circ}\text{fh}$  or  $8.4^{\circ}\text{dH}$ ) and the reduction of the pH value on the surface of the concrete (e.g. in biofilm). The concrete design, curing and foremost the cleaning of the surface must be adapted to the respective exposure.

While for resistance to mechanical cleaning a hard and compact concrete surface is considered optimal, chemical cleansing is best tolerated by concrete with a high calcite content. Concrete's chemical resistance is limited. If exposure limits are exceeded, concrete surfaces can only be durably protected with appropriate coatings.



*Fig. 8.8.2: As resistance of concrete against chemical attack is limited, protective coatings are often used for external protection. Epoxy resin-based protective coatings are applied over the entire surface following reprofiling of the concrete surface with sulfate-resistant repair mortar enhanced with synthetic material.*

## Concrete mix design advice and recommended measures:

Components	Description	Example formula
Aggregates	Aggregates employed must be of high quality and frost-resistant	All aggregate sizes are possible
Cement	Sulfate resistant cements Cements with high proportion of calcium carbonate; cements containing silica fume	Target cement paste volume as low as possible for the respective placing method
Powder additives	Silica fume, fly ash or ground granulated blast furnace slag	<b>SikaFume®</b> 3 – 6%
Water content	Clean mixing water, free of fines	w/c-ratio according to standards with regard to exposure class < 0.45
Concrete admixture	Superplasticizer Type dependent on placement and early strength requirements	<b>Sika® ViscoCrete®</b> or <b>SikaPlast®</b> or <b>Sikament®</b> 0.80 – 1.60%
Installation requirements and curing	Curing compound Curing that starts as early as possible and is maintained for a sufficient period of time has significant influence on plastic and drying shrinkage	Careful installation and compaction. Subsequent curing to ensure high quality (compaction) of surfaces <b>Sika® Antisol®</b>
Protective system	The chemical resistance of concrete is highly limited. If exposure limits are exceeded, concrete surfaces can be durably protected with coatings	Sika offers a wide range of solutions to prevent the penetration of chemicals. Sika Solution: <b>Sikagard®</b> , <b>Sikafloor®</b> and <b>Sikalastic®</b>

## Sika product use

Product name	Product type	Product use
<b>Sika® ViscoCrete®</b> <b>SikaPlast®</b> <b>Sikament®</b> <b>Plastiment®</b>	Superplasticizer	Improves the consistence
<b>SikaFume®</b>	Silica fume	Reduced permeability
<b>Sika® Separol®</b>	Mold release agent	Easier striking and cleaning
<b>SikaControl® PerFin</b>	Concrete surface improver	Improves finished concrete surfaces by the reduction of pores and blowholes
<b>Sika® Antisol®</b>	Curing agent	Protection from premature drying



## 8.9 HIGH STRENGTH CONCRETE

High strength and ultra high performance concretes are not just cutting edge technologies for scientific research, but also continue to find new applications in practice. Whether in dealing with the slenderness of building components (e.g. design) or dimensional instability under extreme conditions (e.g. earthquake stresses), high and highest material properties (compressive and flexural strength, elasticity and ductility) are finding entry in concrete technology. Durability and high strength of concrete are thereby interdependent.



*Fig. 8.9.1: High strength and above all ultra high performance concrete (UHPC) are usually fiber-reinforced. Depending on the requirements, synthetic and/or steel fibers are thereby employed in large quantity.*

### **High strength concrete (HSC)**

Concretes with high compressive strength ( $> 60$  MPa) after 28 days are classified in the high performance concretes group and are used in many different structures due to their versatile technical characteristics. They are often used in the construction of high load bearing columns and for many products in precast plants. High strength concrete is suitable for application in high rise buildings, especially in earthquake areas. In addition prestressed bridge constructions require high compressive strength leading to wider spans and slender bridge dimensions. Furthermore the outstanding mechanical characteristics of high strength concrete is utilized in structures exposed to high mechanical and chemical loading like industrial floors, traffic areas, offshore structures, sewage treatment plants and engineering structures like hydropower plants or cooling towers.

High strength concrete is characterized as following:

- 28 days compressive strength between 60 and 120 MPa
- Increased tensile and flexural strength
- Low permeable binder matrix leading to high durability
- Reduced creep and enhanced resistance to pollutants

An increased overall binder content does not necessarily lead to higher concrete strength, as the w/b-ratio represents the driving factor for final strength. The workability of the fresh concrete determines the minimum cement content and optimum binder combination.

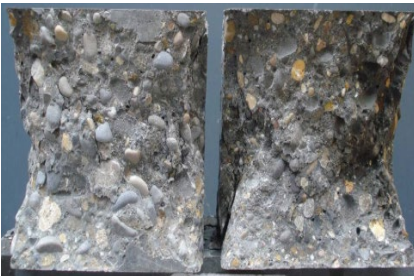

*Fig. 8.9.2: The differences in the quality of aggregates and the w/c-ratio determines whether fractures occur in the aggregates or the cementitious paste at the point of maximum loading. The picture shows a reduction of the w/c-ratio from 0.32 (left) down to 0.28 (right).*

Furthermore attention has to be drawn to the aggregates selection. High quality aggregates which are clean and free from inside cracks are mandatory. In addition the aggregate grading curve can be designed regarding high strength concrete with the following measures:

- Reduced overall sand content
- Reduced amount of fraction 2 to 4 mm
- Reduced fines from aggregates smaller than 0.125 mm
- Increased amount of fraction 0.25 to 1 mm

Note in particular that:

- High strength concrete is always highly impermeable
- Curing of high strength concrete is even more important than usual (limited supply of moisture from inside the concrete)
- High strength concrete is also brittle because of its strength and increased stiffness (impact on shear properties)
- Apart from Portland cement, high strength concrete uses large quantities of latent hydraulic and pozzolanic materials which have excellent long term strength development properties



## Exemplary mix designs and influence of cement and binder content

The table below shows three different concrete mix designs, all representing high strength concrete. It can be derived, that the total binder content has no influence on the final compressive strength. The determining factor is the w/b-ratio. But it has to be pointed out that mixtures having water content below 120 L/m<sup>3</sup> water face extreme workability challenges. Therefore minimum binder content is necessary for ensuring minimum water content in the concrete. An important mechanical characteristic, the E-Modulus, can be increased by reducing the binder content to a minimum.

Total binder	600 kg/m <sup>3</sup>	500 kg/m <sup>3</sup>	400 kg/m <sup>3</sup>
CEM I 42.5 N	570 kg/m <sup>3</sup>	475 kg/m <sup>3</sup>	380 kg/m <sup>3</sup>
Silica fume	30 kg/m <sup>3</sup>	25 kg/m <sup>3</sup>	20 kg/m <sup>3</sup>
Aggregates (round siliceous limestone 0 – 16 mm)	1'696 kg/m <sup>3</sup>	1'849 kg/m <sup>3</sup>	2'001 kg/m <sup>3</sup>
<b>w/b-ratio</b>	<b>0.25</b>	<b>0.25</b>	<b>0.25</b>
Water	150 kg/m <sup>3</sup>	125 kg/m <sup>3</sup>	100 kg/m <sup>3</sup>
Strength after 7 days	87 MPa	85 MPa	88 MPa
Strength after 28 days	93 MPa	98 MPa	96 MPa
E-Modulus	43'800 MPa	47'200 MPa	48'800 MPa

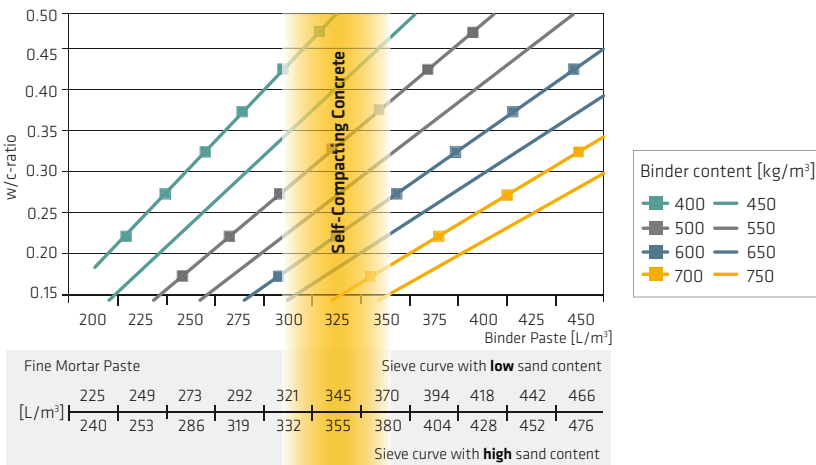

Fig. 8.9.3: Of central significance for achieving of high mechanical strength is the of a concept of fines and the cement paste volume. The highest possible packing density can only be achieved this way.



Fig. 8.9.4: Highly stressed building components such as columns and beams are made of high strength concrete. High resistance to external influences also makes high strength concrete an ideal protective coating for exposed construction elements.

### Concrete mix design advice and recommended measures:

Components	Description	Example formula
Aggregates	Exceptional concrete strength can be achieved using high strength, crushed aggregates	Well distributed grading curve with low amount of fine
Cement	Utilization of higher cement content and high grades	Target cement paste volume as low as possible for the respective placing method
Powder additives	Increased bond between aggregates and cement matrix silica fume	<b>SikaFume®</b> 5 - 10%
Water content	Clean mixing water, free of fines	w/c-ratio according to standards with regard to exposure class < 0.38
Concrete admixture	Superplasticizer Type according to target flowability and slump life	<b>Sika® ViscoCrete®</b> 1 - 4%
	Steel fibers	<b>SikaFiber®</b> Steel 30 - 40 kg/m <sup>3</sup>
Installation requirements and curing	Curing compound Thorough curing which starts as early as possible and is extended to two days for interior elements or three days for exterior elements, especially when silica fume is used	Careful installation and compaction. Subsequent curing to ensure high quality (full compaction) of surfaces <b>Sika® Antisol®</b>

### Sika product use

Product name	Product type	Product use
<b>Sika® ViscoCrete®</b>	Superplasticizer	For maximum reduction of the water content and therefore strengthening of the hardened cement paste
<b>SikaFume®</b>	Silica fume	For further compaction and strengthening of the hardened cement paste and to improve the bond between aggregate and hardened cement paste
<b>SikaFiber®</b>	Steel fibers	Increased impact and abrasion resistance
<b>Sika® Antisol®</b>	Curing agent	Protection from premature drying

## 8.10 SHRINKAGE CONTROLLED CONCRETE

Prevention of cracks contributes to the durability of concrete structures, because cracks promote the ingress of water and pollutants. Current construction codes specify limits for the width of cracks depending on environmental conditions in which a structure is built and its intended service life.

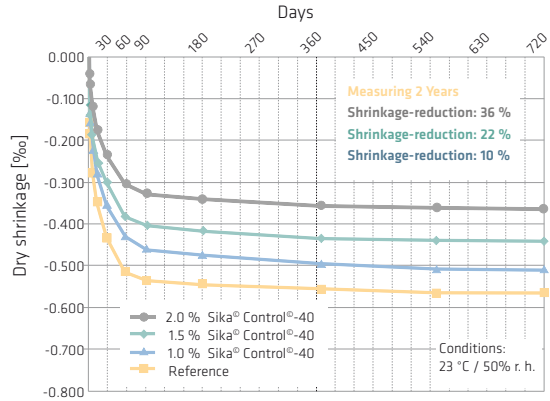

Fig. 8.10.1: Shrinkage behavior of concrete containing shrinkage-reducing admixtures, measured up to 2 years to complete abatement of shrinkage due to drying.

### Concrete shrinkage types

The most important types with the most severe impact are chemical shrinkage, plastic shrinkage, drying shrinkage, autogenous shrinkage and carbonation shrinkage.

In the case of **chemical shrinkage**, hydration products built up during the hydration process occupy lower volume than the total volume of individual raw materials. This results in a decrease of overall concrete element dimensions as long as the concrete is still soft.

**Plastic shrinkage** exhibits itself through a decrease in volume caused by evaporation of water, leading to concrete contraction in all directions. The major portion of shrinkage at early ages is in the horizontal plane, mainly where the surface is contact with air. This is one of the most common and important types of shrinkage. Influencing factors are relative humidity, temperature and ambient wind. More severe drying conditions increase the shrinkage value.

**Autogenous shrinkage** is a change of volume that occurs after the initial setting of concrete due to hydration, since this process requires water and therefore reduces the internal free water.

**Drying shrinkage** in hardened concrete is usually caused by evaporation of water through existing capillary pores in the hydrated cement paste. The loss of water is a progressive process that tends to stabilize with time, depending on the dimensions of the structural element.

Possible measures include a reduction of cement paste volume and application of shrinkage reducing admixture.



Fig. 8.10.2: Immediate coverage or curing of concrete surfaces exposed to the elements is the most crucial step for protection of such surfaces.

### Concrete mix design advice and recommended measures:

Components	Description	Example formula
Aggregates	Large volume of aggregates can reduce drying shrinkage	Well distributed grading curve with low amount of fine
Cement	Drying shrinkage can be reduced by lowering cement paste volume or/and utilization of SCM	Target cement paste volume as low as possible for the respective placing method
Water content	Low water content is favorable to reduce plastic shrinkage and drying shrinkage At w/c-ratios lower than 0.4 autogenous shrinkage can occur	w/c-ratio according to standards with regard to exposure class < 0.45
Concrete admixture	Superplasticizer Type dependent on placement and early strength requirements	<b>Sika® ViscoCrete®</b> or 0.80 – 1.50% <b>SikaPlast®</b> or <b>Sikament®</b>
	Shrinkage reducing agent	<b>SikaControl® SRA</b> 0.5 – 1.5%
	Polypropylene short fibers can reduce effects of plastic shrinkage	<b>SikaFiber®</b> 0.6 – 1.0 kg/m <sup>3</sup>
	Structural fibers to ensure even distribution of cracking	<b>SikaFiber®</b> Steel 20 – 40 kg/m <sup>3</sup> Macro PP 4 – 6 kg/m <sup>3</sup>
Installation requirements and curing	Curing compound Curing that starts as early as possible and is maintained for a sufficient period of time has significant influence on plastic and drying shrinkage	Careful installation and compaction. Subsequent curing to ensure high quality (compaction) of surfaces <b>Sika® Antisol®</b>

### Sika product use

Product name	Product type	Product use
<b>Sika® ViscoCrete®</b> <b>SikaPlast®</b> <b>Sikament®</b>	Superplasticizer	Substantial water reduction Improvement in placing (workability and compaction)
<b>SikaControl® SRA</b>	Shrinkage reducing agent	Reduction of shrinkage
<b>SikaFiber®</b>	Polypropylene fibers Steel fibers	Reduction of effects of plastic shrinkage Even distribution of cracks
<b>Sika® Antisol®</b>	Curing agent	Protection from premature drying

## 8.11 FIBER REINFORCED CONCRETE

The tensile strength and ductility of concrete can be increased with the addition of fibers made of various materials and different geometries. Based on the idea of distributing the reinforcement evenly throughout the concrete, fiber reinforced concrete was developed by adding the fibers directly during the mixing process. Besides the well known steel fibers, nowadays, plastic fibers and hybrid fibers (a mix of different fibers) can be used for additional applications.



*Fig. 8.11.1: Fibers for use in concrete are produced from different materials and qualities of these materials, plus they can have different geometric dimensions and form, according to the required performance of the fresh or hardened concrete.*

The choice of fiber type and fiber geometry depends mainly on the application field. Therefore the geometry, quality and physical properties of the fibers are matched to each application.

Many different properties of the fresh and hardened concrete can be effectively influenced by adding fibers. There are innumerable different types of fibers with different material characteristics and shapes. Correct selection for different uses is important. As well as the actual material, the shape of the fibers is also a critical factor.

The improvement of fire protection is an application where micro polypropylene (PP) fibers are used successfully. Another example where micro PP fibers can be used is to improve the resistance of early age cracks in concrete, where macro and steel fibers are mainly used to improve the strength, resistance and energy absorption of the hardened concrete. Macro fibers can substitute parts of the ordinary steel reinforcement.

Fiber reinforced concrete is used for:

- Industrial flooring
- Sprayed concrete
- Slender structures (usually in precast plants)
- Spalling resistance at high temperatures
- Mortar applications (rehabilitation)

*Table 8.11.1: Main global brands*

Brand name	Product type
SikaFiber®	For macro, micro polypropylene and steel fibers

Sub brands also available:

- Enduro®
- Fibermesh®
- Fibercast®
- Novocon®
- Novomesh®

## EN 14651 Residual Strength Test

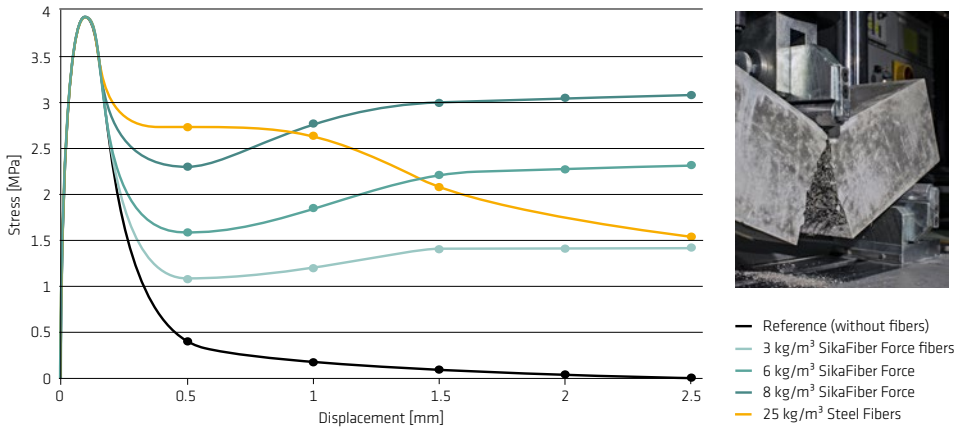

Fig. 8.11.2: The stress-deflection diagram of a bending test shows the influence of different fiber types on the properties of concrete, like improved tensile strength and a well controlled post cracking behavior.

## Concrete production

The fiber manufacturer's instructions must be followed when producing fiber reinforced concretes. Adding the fiber at the wrong time or mixing incorrectly can cause great problems and even make the fibers ineffective.

- Comply with the manufacturer's adding time and method (i.e. at the concrete plant or in the ready-mix truck)
- Comply with the mixing times (balling / distribution of fibers)
- Do not exceed the maximum recommended fiber content (considerable reduction in workability)
- Fibers generally increase the water requirement of the mix (compensate for this with a superplasticizer)

Table 8.11.2: At which state of concrete hardening do which fibers operate the best?

Fresh concrete/mortar	The homogeneity, especially with mortars, is improved by the addition of micro fibers
Until about 10 hours	Early age cracking, formed by plastic shrinkage, can be reduced with micro fibers
1–2 days	Cracks induced by restraint stresses or temperature stresses can be reduced by the use of micro and macro fibers
From 28 days	Forces coming from external loads can be transmitted to macro and steel fibers and the spalling resistance at high temperatures can be improved by micro PP fibers with a melting point at 160 °C



Table 8.11.3: Parameters of different fiber types

Fiber type	Characteristics	Remarks
Steel fibers	Density: ~7'800 kg/m <sup>3</sup> Tensile strength: 400 – 1'500 N/mm <sup>2</sup> E-modulus: ~200'000 N/mm <sup>2</sup>	Steel is by far the most commonly used type of fiber. This is due to their availability, good mechanical properties and durability.
Polypropylene fibers	Density: ~900 kg/m <sup>3</sup> Tensile strength: 600 – 700 N/mm <sup>2</sup> E-modulus: 5'000 – 15'000 N/mm <sup>2</sup>	Polypropylene gives very good alkali resistance and continuous E-modulus improvement over a broad spectrum of uses.
Polyvinyl alcohol fibers	Density: ~900 kg/m <sup>3</sup> Tensile strength: 600 – 700 N/mm <sup>2</sup> E-modulus: 10'000 – 64'000 N/mm <sup>2</sup>	Special manufacturing processes enable high-modulus PVA fibers to be produced.
Vegetable fibers	Density: ~1'500 kg/m <sup>3</sup> Tensile strength: 0 – 1'000 N/mm <sup>2</sup> E-modulus: 5'000 – 40'000 N/mm <sup>2</sup>	Vast natural resources but wide variations in the characteristics, which presents design difficulties.
Glass fibers	Density: ~2'700 kg/m <sup>3</sup> Tensile strength: 2'500 N/mm <sup>2</sup> E-modulus: ~80'000 N/mm <sup>2</sup>	Due to continuous improvements in the alkali resistance (durability), the applications for glass fibers are extending all the time.
Carbon fibers	Density: ~1'700 kg/m <sup>3</sup> Tensile strength: 450 – 4'000 N/mm <sup>2</sup> E-modulus: up to 300'000 N/mm <sup>2</sup>	Very good mechanical properties and high durability on the one hand but high costs on the other.
Polyester fibers	Density: ~900 kg/m <sup>3</sup> Tensile strength: 600 – 700 N/mm <sup>2</sup> E-modulus: 5'000 – 10'000 N/mm <sup>2</sup>	Were developed for the textile industry but can also be found in the construction materials industry.
Ceramic fibers	Density: ~2'500 – 3'000 kg/m <sup>3</sup> Tensile strength: 1'700 – 3'400 N/mm <sup>2</sup> E-modulus: 150'000 – 400'000 N/mm <sup>2</sup>	Are used for heat insulators and lagging, but also for fiber-reinforced ceramics. High strength and E-modulus, but friable.

**Effects of fiber reinforced concretes:**

- Improved durability of the structure
- Increased tensile and flexural strengths
- Higher resistance to later cracking
- Improved crack distribution
- Reduced shrinkage of early age concrete
- Increased fire resistance of concrete
- Negative influence on workability
- Improved homogeneity of fresh concrete

Table 8.11.4 Different fiber types can be used for different types of applications. The following table shows where steel, macro-PP, micro-PP and glass fibers can typically utilized

Application / Fiber Type	Steel fiber small	Steel fiber large	Macro fiber 50 mm	Macro fiber 60 mm	Micro fiber monofilament	Micro fiber fibrillated	Glass fiber
Shotcrete	✓			✓			
Slabs on ground		✓	✓			✓	
Roads			✓				
Early age shrinkage					✓		
Fire protection					✓		
Screeds						✓	✓
Mortars					✓		✓



Fig. 8.11.3: Special testing for sprayed concrete: Energy absorption testing of fiber reinforced sprayed concrete to EN 14488-5.

### Concrete mix design advice and recommended measures:

Components	Description	Example formula
Aggregates	Any quality aggregates possible	All aggregate sizes are possible
Cement	Any cement meeting local standards	Target cement paste volume according to pumping concrete recommendations > 320 kg/m <sup>3</sup>
Powder additives	Limestone, fly ash, silica fume or ground granulated blast furnace slag	Sufficient fines content by adjustment of the binder content Fines including cement > 375 kg/m <sup>3</sup>
Water content	Fresh water and recycling water without requirements regarding fines content	w/c-ratio according to standards with regard to exposure class < 0.48
Concrete admixture	Superplasticizer Type dependent on placement and early strength requirements  Steel fibers Structural macro fibers Polypropylene micro fibers	<b>Sika® ViscoCrete®</b> or <b>SikaPlast®</b> or <b>Sikament®</b> 0.80 – 1.60%  <b>SikaFiber®</b> Steel 20 – 60 kg/m <sup>3</sup> Macro PP 4 – 8 kg/m <sup>3</sup> Micro PP 0.6 – 1.0 kg/m <sup>3</sup>
Installation requirements and curing	Curing compound Curing that starts as early as possible and is maintained for a sufficient period of time has significant influence on plastic and drying shrinkage	Careful installation and compaction. Subsequent curing to ensure high quality (compactness) of surfaces <b>Sika® Antisol®</b>

### Sika product use

Product name	Product type	Product use
<b>Sika® ViscoCrete®</b> <b>SikaPlast®</b> <b>Sikament®</b>	Superplasticizer	Due to the substantial water reduction, there is less excess water in the concrete
<b>SikaFiber®</b>	Polypropylene micro fibers	To strongly increase fire resistance of cementitious material
	Structural macro fibers	To increase mechanical properties of concrete by increasing impact resistance and flexural strength
	Steel fibers	To increase mechanical properties of concrete by increasing impact resistance and flexural strength
<b>Sika® Antisol®</b>	Curing agent	Protection from premature drying

## 8.12 FAIR-FACED CONCRETE

Modern architecture is unimaginable without fair-faced concrete. For decades priority was given to the unique load-bearing properties and unequalled cost/performance ratio as a structural building material. It is only in recent years that the incredible design versatility and the creation of many different finishes have also come to the fore.



*Fig. 8.12.1: Due to the development of SCC (self-compacting concrete), design and construction potential is now almost unlimited, and with special formwork technology and/or specific concrete admixtures, high quality finishes can be achieved even in the most difficult areas.*

### **Concrete with high aesthetical requirements**

In modern architecture concrete is increasingly used as a design feature as well as for the mechanical properties. This means higher specifications for the finish (exposed surfaces). There are many ways to produce special effects on these exposed surfaces:

- Select a suitable concrete mix
- Specify the formwork material and type (the formwork must be absolutely impervious!)
- Use the right quantity of a suitable mold release agent
- Select a suitable placing method
- Use form liners if necessary
- Color using pigments
- Install correctly (compaction, placing etc.)
- Thorough curing

In addition to all of these factors listed, the following are important for the concrete mix:

### **Aggregate/Cement/Water**

- Use minimum fines content and a balanced grading curve as used for pumped concrete
- Cement generally  $> 300 \text{ kg/m}^3$
- Allow for the effect of the cement on the color of the exposed surface
- The water content in a fair-faced concrete requires great care and consistency (avoid fluctuations) and prevent bleeding
- In order to improve surface appearance by preventing the migration of contaminants (found in fly ash and manufactured sands) to accumulation on the surface and to provide a uniform dispersal and stability of color pigment throughout the concrete matrix make the use of SikaControl® SI.



Fig. 8.12.2: With a wide variety of formwork and treatments available, almost any concrete finish can be created, included mirror smooth, plain timber board or other patterns, for example bush hammered or exposed aggregate etc..

## Placing and Curing

- Place the concrete in even layers of 300 to 500 mm. Each layer should be vibrated into the one below (mark the vibrator)
- Use a suitable size of vibrator (example: Wall thickness up to 20 cm → Poker  $\varnothing \leq 40$  mm)
- Concrete should have plastic to soft installation consistence
- Specify thorough curing and allow for the climatic conditions

## Precautions

- Considerable retardation can occur with new, untreated timber formwork due to the pressure of wood 'sugar' on the surface leading to discoloration and dusting
- If the concrete is too 'wet' when placed, water pores with a thin or non-existent cement laitance skin can occur (blowholes)
- Inadequate concrete vibration can result in vibration pores with a hard, thick cement laitance skin (honey combing)
- Excessive mold release agent application prevents the air bubbles (created by vibration) from escaping

## Sika product use

Product name	Product type	Product use
Sika® ViscoCrete® SikaPlast® Sikament®	Superplasticizer	Increased strength and impermeability Substantial water reduction Reduction in capillary porosity
Sika® Separol®	Mold release agent	Easier striking and cleaning
Sika® Rugasol®	Surface retarder	Production of exposed aggregate concrete surfaces
SikaControl® PerFin	Concrete surface improver	Improves finished concrete surfaces by the reduction of pores and blowholes
SikaColor®	Concrete color (liquid or powder)	Creates even and intensive colored concrete
Sika® Antisol®	Curing agent	Protection from premature drying
SikaControl® SI	Surface improver	Improves surface appearance by preventing the migration of contaminants (burned carbon) to accumulation on the surface

## 8.13 COLORED CONCRETE

The manufacture and processing of colored concrete is not only a trend, but also a sustainable and attractive way to design concrete structures or building components. Alongside the shape and surface structure, color is a central design element for concrete as a building material. The effect therefore must reflect the desires of the building owner and the architect, being as uniformly as possible over the whole building component.



*Fig. 8.13.1: Concrete, traditionally a solid, reliable, durable building material can be raised to new levels of architectural performance.*

Colored concrete is produced by adding metal oxide pigments (mainly iron oxide). The pigments are in the form of powder, fine, low dust granulates or liquid suspension. The dosage is normally 0.5 – 5.0% of the cement weight. Higher dosages do not enhance the color intensity but may adversely affect the concrete quality.

### **Typical primary colors are:**

- Synthetic iron oxide yellow and red
- Synthetic iron oxide black (note: carbon black may adversely affect the creation of air voids)
- White (titanium dioxide; general brightener)

Out of the major primary colors a wide range of concrete colors could be created and there are almost no limits of creativity. In addition special colors are available.

### **The coloring can be heightened or structured:**

- By using light colored aggregate and or by using white cement
- By using special types of forms (shuttering)

### **The main factors for the successful colored concrete construction and finishes include:**

- Preliminary trials and agreed finishes, with the results visible for all parties.
- A constant workflow throughout the concreting works from the mix design, trials, production, transport, formwork, placing, curing and protection of the concrete surfaces. The parameters must be maintained in accordance with the preliminary trials.
- Consistent water content in the concrete mix is one of the most important variables.



Fig. 8.13.2: Colored concrete demands far more than just adding the pigments. From planning to installation, essential decisions must be made for the application to succeed and the most diverse production steps must be checked and executed expertly. The picture shows a Sika Scofield Granular Color Dispenser at a concrete plant.

The significance of the formwork influence on the aesthetic aspect of the colored fair faced concrete must be discussed with the project owner before the test panel application:

- Material of the formwork (steel, wood, plastic, ...)
- Structure of the surface (smooth or rough)
- Tightness and cleanness of the formwork (especially joints, new or used forms)
- Robustness of the formwork construction
- Mold release agent (type, application thickness & consistency)
- Placing and compaction of concrete in the formwork
- Curing

#### When using liquid pigments:

- Faster and more efficient dosing (larger volumes)
- Clean and easy to use
- Limited storage times
- Needs frost protection
- Short mixing times

#### When using powder pigments:

- Smaller applications (lower volumes)
- Does not need protecting from frost
- Hand/manual dosage possible

#### When using granular pigments:

- Low dust, clean to use
- Does not need protecting from frost
- Hand / manual dosage possible
- Adequate mixing times required

#### Sika product use

Product name	Product type	Product use
Sika® ViscoCrete® SikaPlast® Sikament®	Superplasticizer	Increased strength and impermeability Substantial water reduction Reduction in capillary porosity
SikaColor® Liquid	Liquid/powder/granular colors	Pigments for integral coloring of mortar and concrete
Sika® Scofield® CHROMIX-It®	Color dispensing systems	Specific pigment dosing and dispensing system for all type of applications

## 8.14 UNDERWATER CONCRETE

As the name suggests, underwater concrete is installed below the water line, e.g. for:

- Port and harbor installations
- Bridge piers in rivers
- Water industry structures
- Metro systems
- Deep shafts in unstable ground



*Fig. 8.14.1: When using underwater concrete, the placing and working conditions are very often complex, which is why these concretes often also need an extended working time.*

### **Composition (Example 0 – 32 mm):**

- Aggregate
  - Use an aggregate suitable for pumped mixes
  - Fines including cement > 400 kg/m<sup>3</sup>
- Cement and Powder Additives
  - Minimum cement content 350 kg/m<sup>3</sup>
  - Limestone can be added to the fines content in the mix design
- Admixtures
  - Superplasticizer for the reduction of free water in the mix
  - Mix stabilizer to minimize washout effect of fines and cement (especially in running water conditions)

### **Special requirements**

Standard method is pumping a suitably modified mix through a standard concrete pump. The end of the delivery pipe must be kept deep enough in the fresh concrete.

Another method of placing underwater concrete with minimum loss is the tremie process (Contractor Method). The concrete is placed directly through a 20 – 40 cm diameter pipe into and through the concrete already installed. The pipe is raised continuously, but the bottom end must always remain sufficiently submerged in the concrete to prevent the water going back into the pipe.

Other important considerations:

- As the flow rate of water increases, more leaching can occur, it is possible to design the concrete to minimize washout at various water flow rates
- Avoid pressure differences on the pipe (such as water level differences in shafts)

### **Special underwater concrete**

Previously installed rough stone bags or “gabions” can be infilled later with modified cement slurries (the bag method).



Fig. 8.14.2: Concrete poured underwater with-out (left) and with Sika® Stabilizer UWC (right).

### Concrete mix design advice and recommended measures:

Components	Description	Example formula
Aggregates	Any quality aggregates possible	All aggregate sizes are possible
Cement	Any cement meeting local standards	Target cement paste volume according pumping concrete recommendations $> 350 \text{ kg/m}^3$
Powder additives	Limestone, fly ash or ground granulated blast furnace slag	Sufficient fines content by adjustment of the binder content Fines including cement content $> 400 \text{ kg/m}^3$
Water content	Fresh water and recycling water without requirements regarding fines content	w/c-ratio according to standards with regard to exposure class $< 0.48$
Concrete admixture	Superplasticizer Type dependent on placement and early strength requirements  Stabilizer for stagnant water Stabilizer for running water	<b>Sika® ViscoCrete®</b> or <b>SikaPlast®</b> or <b>Sikament®</b> 0.60 – 1.50%  <b>Sika® Stabilizer</b> 0.20 – 2.00% <b>Sika® Stabilizer UCS / UWC</b> 0.30 – 1.50%
Installation requirements and curing	Curing compound Curing that starts as early as possible and is maintained for a sufficient period of time has significant influence on plastic and drying shrinkage	Careful installation and compaction. Subsequent curing to ensure high quality (compactness) of surfaces <b>Sika® Antisol®</b>

### Sika product use

Product name	Product type	Product use
<b>Sika® ViscoCrete®</b> <b>SikaPlast®</b> <b>Sikament®</b>	Superplasticizer	Increased strength and impermeability Substantial water reduction Reduction in capillary porosity
<b>Sika® Stabilizer VMA</b>	Viscosity modifying agent	Improved cohesion of the concrete
<b>Sika® Stabilizer UCS / UWC</b>	Cohesion improver	Strong improvement of cohesion for underwater concrete
<b>Sika® Stabilizer Pump</b>	Pumping aid	Improves pumpability and support cohesion
<b>SikaTard®</b>	Setting retarder	Extended workability by retarding setting point
<b>SikaFume®</b>	Silica fume	Reduced permeability and increased density



## 8.15 LIGHTWEIGHT CONCRETE

Lightweight means concrete and mortar with a low density. Concrete incorporating either aggregates with a lower density or artificial voids are created to reduce the weight. The method used depends mainly on the lightweight materials available, the application and the desired concrete properties.



*Fig. 8.15.1: The compressive strengths obtainable are always linked to the density of the materials. The level of this correlation can be altered through the quality of the aggregates. As expected, voids result in very low strength. So-called expanded clays can also give very good strength development at low densities of approximately  $1500 \text{ kg/m}^3$ .*

### **Lightweight concrete is used for:**

- Lightweight construction (ceilings, walls, bridge decks, slabs)
- Levelling concrete
- Infill concretes
- Thermal insulation

### **Characteristics of lightweight concretes:**

- Reduction in fresh concrete density and in hardened concrete density
- If lightweight concrete is used as an infill concrete with low load bearing requirements i.e. for dimensional stability, highly porous concretes and mortars are generally produced (aerated lightweight concrete)
- If lightweight concrete with good mechanical properties (i.e. compressive strength) is required, special aggregates are used (naturally very porous but also dimensionally stable)

### **Production of lightweight concrete:**

- Porous lightweight materials such as expanded clays must be pre wetted to prevent too much water being drawn out of the concrete during mixing
- Due to the risk of segregation do not use a too fluid consistence
- Correct handling of vibrators is particularly important (quick immersion, slow lifting) to prevent air entrapment
- Cure immediately and thoroughly
- Foamed concretes often shrink considerably and have low dimensional stability



Fig. 8.15.2: Foam generated by a foam generator and Sika® Stabilizer Poro to produce cellular / foam concrete.

### Constituents for the production of lightweight concretes:

- Sintered pulverized fuel ash lightweight aggregates
- Expanded clays
- Expanded polystyrene balls, wood shavings, sawdust
- Special void producing admixtures to generate large quantities of defined stable air voids
- Foaming agents

### Density

Based on the mix and the constituents used, the following density classes and properties are obtainable:

Components	Density	Example formula
Aggregate	over 1'800 kg/m <sup>3</sup>	High mechanical properties
Expanded clays	over 1'500 kg/m <sup>3</sup>	Limited mechanical properties
Void producers	over 1'500 kg/m <sup>3</sup>	Porous lightweight concrete with low mechanical properties
	over 1'200 kg/m <sup>3</sup>	No mechanical properties (easy to produce porous lightweight concrete)
Expanded polystyrene	over 800 kg/m <sup>3</sup>	Low mechanical properties
Foaming agents	over 800 kg/m <sup>3</sup>	No mechanical properties such as infill mortar

### Sika product use

Product name	Product type	Product use
Sika® ViscoCrete® SikaPlast® Sikament®	Superplasticizer	To reduce the permeability and improve the workability of lightweight concrete
Sika® Stabilizer Lightcrete	Foaming admixture	To produce low density concrete
Sika® Stabilizer Poro	Foam formers	To generate foam with a special gun to produce cellular mortar ≤ 1'000 kg/m <sup>3</sup>
Sika® Stabilizer Pump	Pumping aid	To improve the pumpability and cohesion of lightweight concrete

## 8.16 HEAVYWEIGHT CONCRETE

The main application for heavyweight concrete is for radiation shielding (medical or nuclear), for offshore and heavyweight concrete is also used for ballasting of pipelines.

Heavyweight concrete uses heavy natural aggregates such as barytes or magnetite or manufactured aggregates such as iron ore and/or lead shot. The density depends on the type of aggregate used and can achieve between 3'000 kg/m<sup>3</sup> and close to 6'000 kg/m<sup>3</sup>.



*Fig. 8.16.1: The floor, walls and ceiling of this medical building were constructed with heavyweight concrete using hematite metallic aggregates to ensure full and secure radiation protection.*

As previously noted heavyweight concrete is mainly used for radiation protection. The critical properties of a heavyweight concrete are:

- Homogeneous density and compaction of the concrete
- Free from cracks and honeycombing
- Compressive strength is often only a secondary criterion due to the large size of the structure
- As free from air voids as possible
- Low heat of hydration
- Low shrinkage

### Composition

- Aggregate
  - Use of barytes, iron ore, heavy metal slags, ferrosilicon, steel granules or shot
- Cement
  - Consider hydration heat development when selecting the cement type and content
- Water content
  - Aim for a low w/c-ratio

### Workability

To ensure a dense concrete matrix, careful consideration should be given to the placing (compaction) and finishing of the concrete.

### Curing

Allowance must be made in the curing method for the high heat development due to large mass of the structure.

Type	Density concrete	Density aggregate
Heavyweight concrete	Higher than 2'800 kg/m <sup>3</sup>	Heavyweight aggregates > 3'200 kg/m <sup>3</sup>
Normal concrete	In the range of 2'000 to 2'800 kg/m <sup>3</sup>	Normal aggregates
Lightweight concrete	Up to 2'000 kg/m <sup>3</sup>	Lightweight aggregates < 2'200 kg/m <sup>3</sup>

Table 8.16.1: Overview about concrete types and densities.

Using barytes the density will be in the region of 3'500 kg/m<sup>3</sup>, while with magnetite the density will be 3'900 kg/m<sup>3</sup>. Very heavy concretes can be achieved with iron aggregates, the density will be above 6'000 kg/m<sup>3</sup>.

### Concrete mix design advice and recommended measures:

Components	Description	Example formula
Aggregates	Use of heavyweight aggregates	Barytes ~ 3'500 kg/m <sup>3</sup> Magnetites ~ 3'900 kg/m <sup>3</sup> Iron aggregates ~ 7'000 kg/m <sup>3</sup>
Cement	Any cement meeting local standards	Target cement paste volume as low as possible for the respective placing method
Powder additives	Ground granulated blast furnace slag	Sufficient fines content by adjustment of the binder content
Water content	Fresh water and recycling water without requirements regarding fines content	w/c-ratio according to standards with regard to exposure class < 0.48
Concrete admixture	Superplasticizer Type dependent on placement and early strength requirements	<b>Sika® ViscoCrete®</b> or 0.60 – 1.50% <b>SikaPlast®</b> or <b>Sikament®</b>
Installation requirements and curing	Curing compound Curing that starts as early as possible and is maintained for a sufficient period of time has significant influence on plastic and drying shrinkage	Careful installation and compaction. Subsequent curing to ensure high quality (compactness) of surfaces <b>Sika® Antisol®</b>

### Sika product use

Product name	Product type	Product use
<b>Sika® ViscoCrete®</b> <b>SikaPlast®</b> <b>Sikament®</b>	Superplasticizer	Substantial water reduction Improvement in placing (workability and compaction)
<b>SikaFume®</b>	Silica fume	Reduced permeability
<b>Sika® Antisol®</b>	Curing agent	Protection from premature drying

## 8.17 SPUN PILE CONCRETE

Pre-stressed concrete piles can be widely used as foundation pile for Power Projects, Steel Plants, High Rise Buildings, Civil Engineering works, Bridges, Marine Structures and Harbors etc.

Spun concrete piles are produced by centrifugal compaction process.

Typical concrete specification:

- Slump: 20 – 40 mm
- Strength grade: 80 MPa
- The compressive strength at the time of prestress introduction shall be 40 MPa (cylinder) or more

### Composition

- Aggregate
  - Coarse aggregate size 67 (4.75 – 19 mm) ASTM C33: 1'200 – 1'300 kg/m<sup>3</sup>
  - Fine aggregate: ASTM C33
- Cement
  - Dosage 440 – 480 kg/m<sup>3</sup>, usually Portland cement
- Additives
  - Silica fume for high strength or in marine environment
- W/c-ratio
  - 0.20 – 0.25
- Concrete admixture
  - To ensure the fresh concrete properties and high early strength after 4 – 5 hours steam curing of spun pile, the application of a powerful superplasticizer based on polycarboxylate-ether (PCE), like Sika® ViscoCrete® technology, is mandatory.



## Typical mix design of C80 spun pile concrete

Mix Proportion for 1 m <sup>3</sup>				
Cement [kg]	Sand (0 – 5 mm) [kg]	Coarse aggregates (5 – 20 mm) [kg]	Sika® ViscoCrete® [L]	Water [L]
460	730	1260	4.6	110

### Concrete mix design advice and recommended measures:

Components	Description	Example formula
Aggregates	Any quality aggregates possible	All aggregate sizes are possible Recommended by ASTM up to 19 mm
Cement	Any cement meeting local standards	Target cement paste volume as low as possible for the respective placing method
Water content	Clean mixing water, free of fines	w/c-ratio according to standards with regard to exposure class 0.20 – 0.25
Concrete admixture	Superplasticizer Type dependent on placement and early strength requirements	<b>Sika® ViscoCrete®</b>
Installation requirements and curing	Curing that starts as early as possible and is maintained for a sufficient period of time has significant influence on plastic and drying shrinkage	<b>Sika® Antisol®</b>

### Sika product use

Product name	Product type	Product use
<b>Sika® ViscoCrete®</b>	High range water reducer	Water reduction Good initial strength development
<b>SikaFume®</b>	Silica fume	High strength, increased impermeability
<b>SikaRapid®-1</b>	Hardening accelerator	Increased early strength
<b>Sika® Separol®</b>	Mold release agent	Contribute to a visually uniform and durable concrete surfaces

## 8.18 PERVIOUS CONCRETE

Pervious concrete, sometimes referred to as “no-fines concrete”, is a mixture of hydraulic cement, coarse aggregate of smaller size, admixtures and water. Pervious concrete allows the water to percolate through the concrete into the sub-base and recharge the underground water level. Typically, pervious concrete does not contain any sand and its air void content varies between 15 and 30%. A small amount of sand can be used for compressive strength improvement, but air void content will be reduced, and permeability lowered. It is important to maintain the proper volume of paste / mortar in the mix design so that the aggregate is equally coated, but the excess of paste / mortar does not fill the void space within coarse aggregate. Voids within the pervious concrete should be interconnected so they create channels through which water can freely flow.

Pervious concrete can be used in following applications:

- Outdoor parking
- Residential roads and alleys
- Pavements
- Structural wall applications where lightweight or better thermal insulation or both are required
- Permeable shoulders and edge drain
- Drainage layers
- Floors free of standing water (greenhouse, tennis courts, swimming pool decks)
- Bridge embankments

### Placing and compaction

Pervious concrete can be placed directly from ready mix truck, via belt conveyors or manually. Pervious concrete due to its plastic properties cannot be pumped (dense stream). When in place strikeoff is performed manually or by laser screed and compaction can start. Sometimes screeding can be combined with compaction in one step. Several techniques are available today to place pervious concrete:

- Manual Steel Rollers
- Manual compactors
- Manual vibratory screeds
- Automated spinning tubes (Mechanical properties prohibit to use pervious concrete in certain application)
- Modified road finishing machine

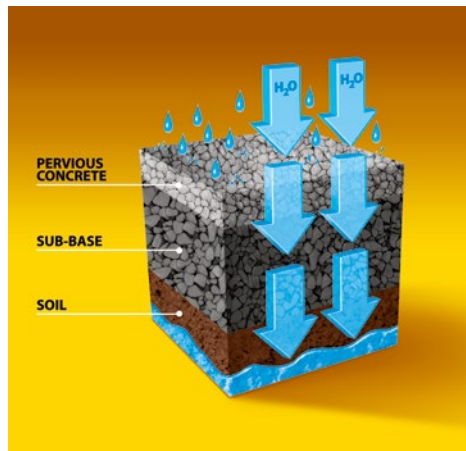

Areas where it is hard to reach such as edges or corners should be tamped manually to ensure proper density and reduce raveling.

## Curing

The most critical step to make strong and durable concrete is proper curing. Without proper curing water is quickly evaporating throughout the increased surface area of the product. Fast coverage is absolute must if maximum strength is required.

The conventional concrete allows to evaporate water only from the top surface while pervious concrete with its porosity allows water to evaporate from much larger area. Pervious concrete should be covered as soon as possible by plastic sheet to keep moisture inside and allow concrete hydrate properly.

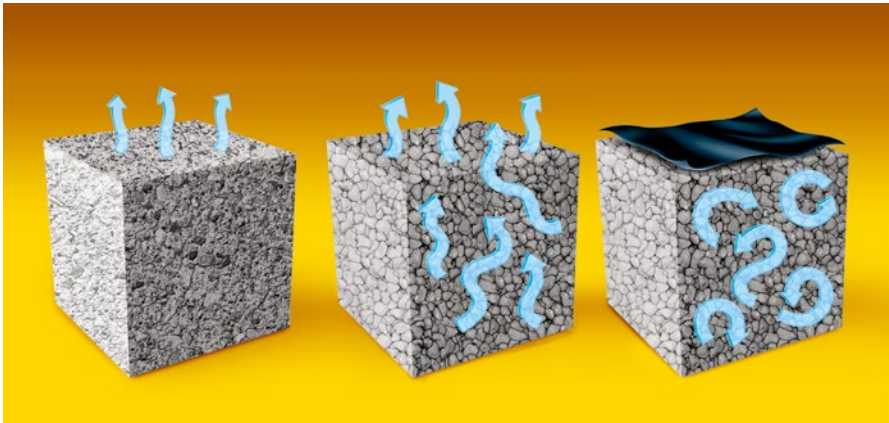

## Ground water level

Allowing water to penetrate back into ground does improve our living environment in several ways.

- Reduces risk of flooding
- Reduced runoff decreases pollution of water sources
- Improves quality of landscaping and reduces need for watering (Flower beds and adjacent trees)
- Recharges the ground water level
- Reduces the size and sometimes the need for storm water runoffs

## Urban heat

Pervious concrete pavement helps to fight urban heat islands by natural reduction of surface temperature and heat. It was found out through Cool Communities program that temperatures within cities are 5 -10 K higher than in rural areas. This significantly increases the amount of energy needed for cooling. Due to lighter color and open pores structure of pervious concrete, absorbed heat is much lower compare to conventional black top surfaces.

- Does not create heat islands due to its light color
- Natural cooling effect by evaporation of absorbed water



## **Water pollution**

Parking lot runoffs are considered as largest pollutant of water in the cities. Pervious concrete reduces significantly number of runoffs and allows water to be treated by natural filtration through soil bed.

- Allows for the natural treatment of polluted water by soil filtration
- Reduces risk of flooding and top soil wash away

## **Health and Safety**

Allowing water to penetrate back into ground does improve and the special structure of the pervious concrete lead to:

- Reduction of noise level caused by traffic ( $\geq 5$  dB(A))
- High sound absorption (up to 98% in critical frequency range)
- Prevents glare – Pervious concrete surface does not glare especially at night when road is wet
- Reduces hydroplaning / aquaplaning by reduction of flood spots
- Reduction / Elimination of water spray
- Improvement of the grip (tires / road)

## **Challenges**

As any construction material pervious concrete has limitation that must be understood. Pervious concrete can be only as good as designed and installed. As pervious concrete is a system of several components, each section must be installed properly to make sure .that the system is going to function.

Basic criteria for pervious concrete are:

- Pervious concrete should be used on flat or low grade areas only
- Sub base preparation is more demanding compare to conventional concrete
- Mechanical properties prohibit to use pervious concrete in certain application
- Maintenance may be necessary to preserve percolation properties
- Higher initial cost than blacktop

## **Technology**

In case that pervious concrete is quality of pervious concrete is based on several criteria. Permeability, compressive strength and flexural strength are important from the owners perspective, the ease of placement plays huge role from the contractor's point of view.

## **Economics**

Savings and other benefits that come with the usage of pervious concrete are due mostly to the following factors:

- Reduces or eliminates the need for storm sewers or retention ponds
- Increases facilities for parking by reducing water retention areas
- Increases permeable area and may qualify for permeable area credit
- Recognized by Leadership in Energy and Environmental Development (LEED)
- Requires less costly repairs than black top
- Longer service life and lower life cycle cost than asphalt

## Concrete mix design advice and recommended measures:

Components	Description	Example formula
Aggregates	Any quality aggregates possible	Coarse aggregates depending on designed permeability (e.g. 5 – 11 mm)
Cement	Any cement meeting local standards	Target cement paste volume as low as possible for the respective placing method and needed amount to cover the surface of the used aggregates
Water content	Clean mixing water, free of fines	w/c-ratio according to standards with regard to exposure class 0.26 – 0.45
Concrete admixture	Superplasticizer Type dependent on placement and early strength requirements  Polymer or polypropylene monofilament fibers  Special admixtures Special admixtures can act as a bonding agent between cement paste and aggregates and allows for stronger bond between paste / mortar and aggregates.	<b>Sika® ViscoCrete®</b> or <b>SikaPlast®</b> or <b>Sikament®</b>     <b>SikaMix</b> <b>10 – 25%</b>
Installation requirements and curing	Curing that starts as early as possible and is maintained for a sufficient period of time has significant influence on plastic and drying shrinkage	Curing sheets

## Sika product use

Product name	Product type	Product use
<b>Sika® ViscoCrete®</b> or <b>SikaPlast®</b> or <b>Sikament®</b>	Superplasticizer	Reduction of w/c-ratio to reduce capillary porosity
<b>SikaMix</b>	Latex based admixtures	Improve workability Reduction of compaction effort Improvement in compressive and flexural strength

# 9 WHITE BOX CONCEPT

Concrete structures such as below ground basements normally have to be watertight to prevent damage due to moisture or water ingress. This can be achieved by applying an external waterproofing system either as coatings, membranes or other surface applied systems or by using an integral waterproofing system that renders the structural concrete watertight.



It is well known, that concrete can be designed to be impermeable to water pressure through careful mix design and admixtures modification, but to keep a concrete structure completely watertight, more than just the concrete design has to be taken into consideration.

There are many expressions used worldwide that describe a 'watertight concrete'. In general, we can differentiate between 'Waterproof Concrete', 'Watertight Concrete Systems' and 'White Box Concept'.

## **Waterproof Concrete** (see Chapter 8.1)

Waterproof concrete describes the concrete mixture, which is impermeable to water and is focused on the quality of concrete, which has been modified using concrete admixtures such as superplasticizers and pore blockers. Because this includes only the concrete mix design, the joints and design of a basement are not considered. Therefore waterproof concrete does not indicate the watertightness of a specific concrete structure.



Waterproof  
Concrete

## **Watertight Concrete Systems**

This term reflects a system consisting of waterproof concrete together with joint sealing solutions to build simple designs of watertight basements. Building a below ground concrete basement will include various working steps that incorporate construction and movement joints as well penetrations. To ensure that the appropriate level of watertightness can be achieved, general guidance for the concrete mix design, construction and concreting are to be provided.

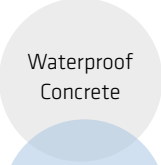

Waterproof  
Concrete



Joints

## White Box Concept

The next level of a watertight structure is the white box concept, which has been established, mainly in Central Europe, for many decades. In addition to waterproof concrete the white box concept includes the planning, design and all operations to be undertaken on site during the construction, in order to obtain a watertight basement. The main solution to achieve this goal, is the production of high quality concrete with focus on control crack formation. To achieve this, all cracks in the concrete must be very fine and well dispersed with no separation cracks going through the whole structure that would allow the transmission of water. Various standards for white box construction require a maximum single crack width  $\leq 0.2$  mm. Important elements that affects the crack formations are:

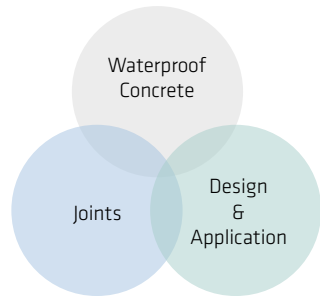

- **Concrete mix design:** An optimized granulometry and w/c-ratio; the selection of appropriate type of cement; an improved rheology and the use of various admixtures as shrinkage reducer, pore blockers, superplasticizers, etc. result in a limited crack formation within the concrete.
- **Concrete thickness:** A homogenous volume of the concrete, without any changes of thickness, reduces local stress points. A minimum concrete thickness of  $\geq 250$  mm for walls and base slabs shows good practice.
- **Grade of steel reinforcement:** This is the key design element to limit crack formation. The amount of steel reinforcement normally is significantly higher than that needed for the structural integrity only. Calculation of the minimum steel grade and distribution should be carried out by a Structural Engineer who will be familiar with the local standard.
- **Shape and layout:** To reduce stress within the structure, the layout of a 'White Box' basement shall be designed at one level and in simple rectangular shape. Offsets or inside corners must be avoided.

Suitable and unsuitable component design configurations are contrasted below in Fig. 9.1

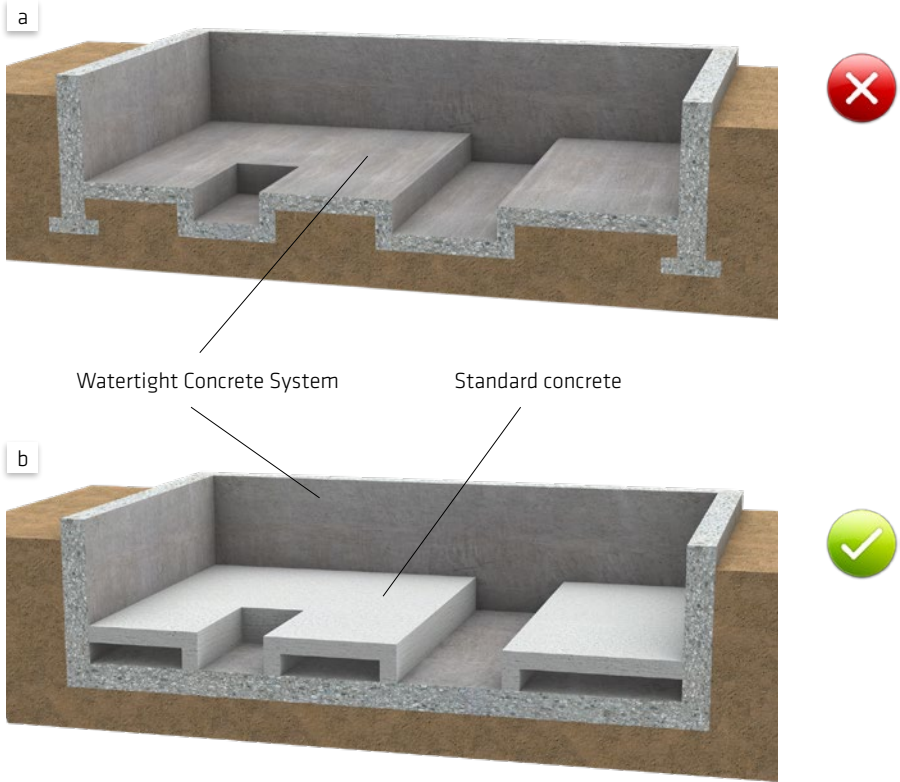

Figure 9.1: Examples of unsuitable (a) and suitable (b) basement design configurations for selection of a Sika Watertight Concrete System

■ **Design of joints:** The selection and definition of construction and movement joints has to be carried out according to the shrinkage behavior of concrete and the concreting stages. Joints should be positioned in order to split the base slab into regular square areas to reduce stress. Site conditions such as water pressure, underground and climatic conditions have to be taken into consideration. Design requirements are different depending on the method and purpose of use.

For joint sealing, PVC waterstops (for construction and movement joints), swelling profiles or injection hose systems (both only for construction joints) are mainly used.

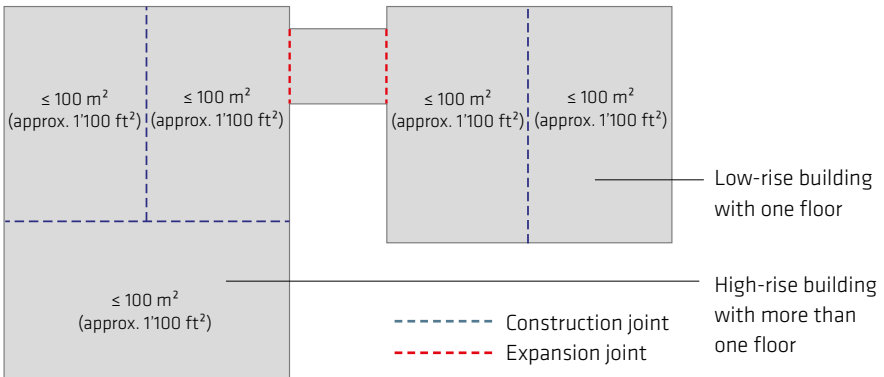
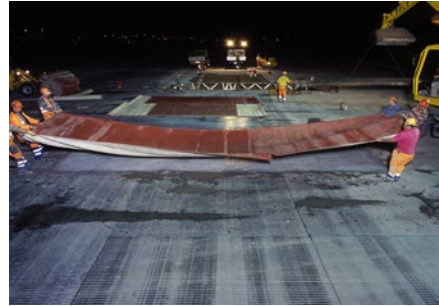

Figure 9.2: Example of the typical layout for concrete construction and movement (expansion) joints

- **Preparation on site:** To reduce friction between the concrete base slab and the ground, a double layer of plastic foils will be required.
- **Concrete placement:** The structure, shuttering system and reinforcement have to allow good and easy concreting. A proper placing of concrete is required to prevent stresses and leakages and uncompacted or segregated concrete. This can be achieved by pouring each section (from joint to joint) continuously in one step without any breaks. By limiting the drop height to  $\leq 1.0$  m and by careful compaction of the fresh concrete, honeycombs can be eliminated.
- **Curing:** An adequate curing for at least three days using plastic foils or curing agents is necessary to prevent cracks due to dry shrinkage.



In addition to these detailed points for crack reduction, there are other points that affect the water tightness of the White Box construction:

- Minimum concrete cover ( $\geq 30$  mm)
- Use of cementitious steel spacer
- Correct positioning and sealing of all penetrations

### **Advantages of White Box Concept**

Compared to traditional external applied waterproofing system, the White Box concept includes the following advantages:

- Concomitant static and sealing function
- Simplified static and constructional design principles
- Easy and fast application, no additional application of waterproofing layer required (less working steps)
- Durable and integral waterproofing system
- No drainage or double walls required
- Simple excavation and less substrate preparation
- Relative independence on weather conditions
- Leakages can be located and repaired more easily
- Less susceptible to external damages

All these advantages result in a cost effective solution and in addition reduce the complexity of site logistics.





# 10 CONSTRUCTION SITE RECOMMENDATIONS

## 10.1 FORMWORK PREPARATION

The quality of concrete is influenced by many factors, whereas formwork preparation plays a major role for the final appearance of the concrete surface. The challenge is to prevent adhesion of the hardened concrete on the formwork and ensure easy cleaning of it. This can be achieved with correct application of a suitable mold release agent, which additionally leads to smooth and dense concrete surfaces improving the durability as well as the aesthetical appearance of the concrete surface.



The following requirements are specified for the action of mold release agents (MRA), both in situ / cast in place situations, and for precast concrete applications:

- Easy and clean release of the concrete from the formwork (no concrete adhesion, no damage to the formwork)
- Visually perfect concrete surfaces (impermeable surface skin, uniform color, suppression of void formation)
- No adverse effect on the concrete quality on the surface (no excessive disruption of setting, no problems with subsequent application of coatings or paints – or clear instructions for additional preparation are required )
- Protection of the formwork from corrosion and premature ageing
- Easy application
- Lowest impact on the environment
- High level of Ecology, Health and Safety on the construction site and in the precast plant

Another important requirement specifically for precast works is high temperature resistance when heated formwork or warm concrete is used. Unpleasant odor development is also undesirable, particularly in a precast factory. For site use, an important requirement is adequate rain or UV resistance, and possible accessibility after the mold release agent has been applied.

## Structure of mold release agents

Mold release agents can be formulated from up to three different material groups:

### ■ Release film formers

These are the materials which are the base substances mainly responsible for the release effect, e.g. various natural and synthetic oils and also paraffin waxes are used.

### ■ Additives

Additional or intensified effects are obtained with these materials. They include release boosters, 'wetting' agents, anti-corrosion additives, preservatives and the emulsifiers which are necessary for water based emulsions. Most of the mold release agents in use today also contain other additives, some of which react chemically with the concrete, causing targeted disruption of setting. It is then much easier to release the concrete from the formwork and the result is a more general purpose product.

### ■ Thinners

These products act as viscosity reducers for the release film formers and additives. Their purpose is to adjust the workability, layer thickness, drying time, etc.. Thinners are basically organic solvents or water for emulsions.

As a result there are three different general technologies employed on which mold release agents are based on:

- Full oils
- Solvent based
- Water based emulsions

The thinner the mold release agent film the better the final concrete surface appearance. Solvent based mold release agents and water based emulsions were developed, because these technologies facilitate fast and easy application of thinnest mold release agent films.



## Mold release agents for absorbent formwork

For unused new timber formwork, the absorbency of the timber is very high. If the formwork is not correctly prepared, the water will be drawn out of the concrete surface from the cement paste. The results seen will be concrete adhesion to the formwork, and future dusting of the hardened concrete surface due to a lack of cement hydration. The concrete layer near the surface can also be damaged by constituents in the formwork (e.g. wood sugars). This manifests itself as powdering, reduced strength or discoloration, and occurs particularly when timber formwork have been stored unprotected outdoors and are exposed to direct sunlight. The effects described can all be quite pronounced when formwork is used for the first time but gradually they decrease with each additional use.

A simple way of counteracting these problems with new formwork has been developed and it has proved effective in practice. Before being used for the first time, the timber form is treated with mold release agent and then coated with a cement paste or thick slurry. The hardened cement paste is then brushed off. After this artificial aging, a mold release agent with some sealing effect should be applied initially for a few concreting operations. A low solvent or solvent-free, weak chemically reactive release oil should generally be used for this.

When timber formwork has been used a few times, its absorbency gradually decreases due to increased surface sealing as the voids and interstices of the surface fill with cement paste and release agent residues. Therefore older timber formwork only needs a thin coat of mold release agent. It is also possible to use mold release agents containing solvents or release agent emulsions on this older formwork.

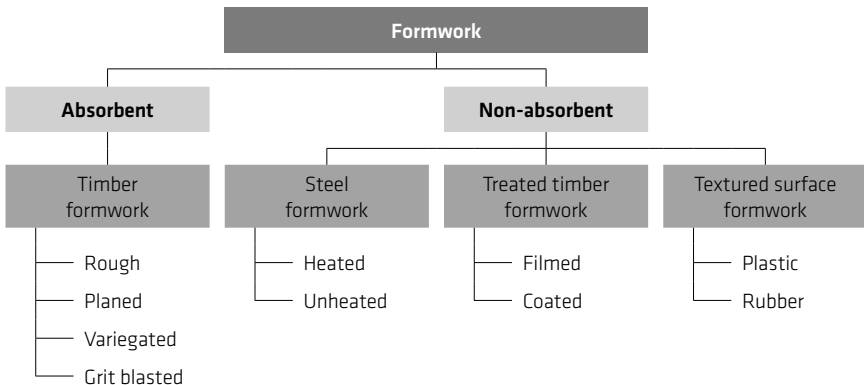

### **Mold release agents for non-absorbent formwork**

Forms made from synthetic resin modified timber, plastic or steel are non-absorbent and therefore cannot absorb release agent, water or cement paste. With all these materials it is extremely important to apply the release agent sparingly, evenly and thinly. 'Puddles' should be avoided. They do not only result in increased void formation but can also cause discoloration and /or dusting of the concrete surface.

To obtain a thin and even release agent film on the form surface, low-viscosity oils with release additives are generally used, often also with solvents for fair-faced concrete. The release additives give improved release (e.g. with fatty acids or specific 'wetting' agents) and also better adhesion of the release film to smooth, vertical form surfaces.

This is particularly important where there are high formwork walls, considerable concrete pouring heights causing mechanical abrasion of the form surface, or the effects of weather and long waiting times between release agent application and concrete placing.

Heated steel forms represent a special application. The release film formed on the formwork must not evaporate due to heat and the release agent must be formulated so that a stronger chemical reaction (lime soap formation or saponification) cannot occur between the concrete and the release agent constituents during the heat treatment.

Textured forms made from special rubber or silicone rubber do not always require release agent, at least when new, because concrete does not stick to the smooth, hydrophobic form surface. If there is a need for release agent due to the form texture or increasing age, products containing solvents or special emulsions should be used dependent on the texture profile. A thin coat is necessary to prevent surplus release agent accumulating in lower lying parts of the form. A suitability test must be carried out to ensure that the release agents used do not cause the form to swell or partly dissolve.

The most favorable mold release agents for non absorbent formwork are water based emulsions, especially in precast concrete production. With this technology thinnest mold release agent films can be achieved, whereas fast and easy application is supported by its white dotted appearance, if correctly applied. Moreover water based emulsions are characterized by a high degree of efficiency and ecology. Raw material consumption is reduced and the working environment in precast concrete plants is improved.

## Directions for use

There are a few general directions for use in addition to the specific release agent product information.

### Application of release agent

The most important rule is to apply the absolute minimum quantity as evenly as possible. The theoretic value to achieve optimum release performance in general would be a mold release agent thickness of 1/1'000 mm. The method of application for a release agent depends mainly on the consistence of the product. Low viscosity (liquid) products should preferably be applied with a high pressure spraying gun with an operating pressure of 3 to 6 bar. Use a flat spraying nozzle possibly combined with a control valve or filter to prevent excess application with runs and drips.

### Application of a water based emulsion

Water based emulsion mold release agents should be applied in thin layers with a fine, white dotted appearance, covering the complete surface. After application one should allow for a water evaporation time of approximately 10 to 20 minutes, depending on ambient temperatures. During this evaporation time a thin uniform oil film is formed.

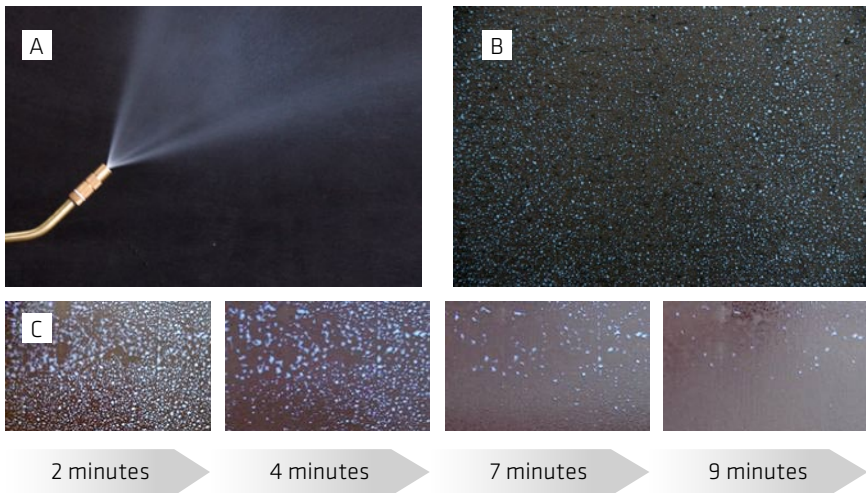

Fig. 10.1.1: Spraying of water based emulsion MRA (A), correct amount of emulsion on the formwork surface (B) and development of evaporation rate over time (C)

On smooth formwork, the correct, uniform release agent thickness can be checked by the 'finger test'. No visible finger marks or release agent accumulations should be formed. Surplus release agent must be removed from horizontal formwork with a rubber or foam squeegee and the surface must be rubbed over. If too much material is applied on vertical or sloping formwork, runs on the surface or release agent accumulations at the base of the form will be visible. They must be removed with a cloth or sponge.

Very high viscosity release agents (e.g. wax pastes) are applied with a cloth, sponge, rubber squeegee, brush, etc.. Here again, only apply the absolute minimum quantity and as evenly as possible.

### Checking the correct release agent application rate

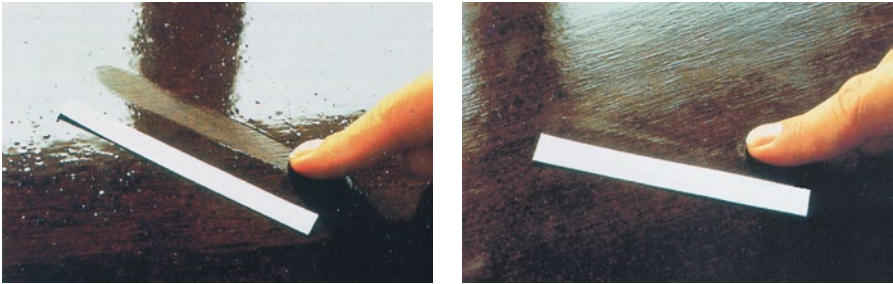

Fig. 10.1.2: Finger test of correct MRA application (left: too much MRA / right: good application of MRA)

The weather conditions play an important part in the use of release agents. It is not appropriate to apply a release agent in the rain due to potential inadequate adhesion and water on the form. Absorbent forms may have a higher release agent requirement in strong sunlight and drought. Release agent emulsions are at risk in frosty weather as the emulsion is destroyed once it is frozen.

### Waiting time before concreting

A specific minimum waiting time between applying the release agent and concreting cannot generally be given, as it depends on many factors such as form type, temperature, weather and release agent type. The correct drying time of products containing solvents and water-based emulsions must always be maintained, otherwise the required release effect is not achieved. The quality of the concrete finish can also suffer because entrapped solvent residues can cause increased void formation.

The evaporation rate varies according to the type of solvent. The waiting times for each product should be taken from the Product Data Sheets.

Exposure or stress (foot traffic, weather etc.) on the release agent film and too long a time delay between application and concreting can reduce the release effect in some circumstances. With absorbent formwork this can happen after a period of a few days. Non-absorbent formwork is less critical and the effect of the release agent is generally maintained for a few weeks, dependent on the ambient conditions.

### Summary

The concrete industry cannot do without release agents. When correctly selected and used with the right formwork and concrete quality, they contribute to visually uniform and durable concrete surfaces. Inappropriate or wrongly selected release agents, like unsuitable concrete raw materials and compositions, can cause defects and faults in and on the concrete surface.

**The Sika® Separol® range offers ideal solutions for most form release requirements.**

### Sika product use

Product name	Product use
<b>Sika® Separol® F</b>	Suitable for all construction site applications and precast concrete applications where an immediate use of the formwork is essential.
<b>Sika® Separol® S</b>	Products offering enhanced concrete surface appearance in all kinds of concrete construction applications.
<b>Sika® Separol® W</b>	Improved release power, fast and easy application with the capability to produce fair-faced concrete surfaces fulfilling high aesthetical requirements.





## 10.2 CONCRETE INSTALLATION

Durable concrete constructions can only be built with correct installation of fresh concrete. Among the entire production chain the installation and vibration of concrete represent critical steps.

Correct placing of fresh concrete leads to

- Durable constructions
- Improved overall quality
- Ensured hardened concrete performance
- Functionality of mold release agents
- Enhanced surface appearance



### Pouring

Several measures have to be considered when fresh concrete is placed.

First of all it is important to check if all concrete characteristics are on site as previously prescribed according to the relevant standards and additional requirements. Especially workability of the concrete should be sufficient in order to ensure easy and save placing as well as subsequent vibrating and finishing.

Regarding the applied mold release agent it is important to ensure that it suffers as little mechanical stress as possible. If possible the concrete should not be poured diagonally against vertical formwork to prevent localized abrasion of the release film. The pour should be kept away from the form as much as possible by using tremie pipes.

Avoid great falling heights especially with fair-faced and self-compacting concrete in order to avoid segregation and achieve uniform concrete surface appearance.

If a subsequent concrete pour is going to be installed after hardening of the previous pour, the joint between the two concrete parts has to have sufficient roughness in order ensure bonding between the hardened and the fresh concrete. This can be achieved by surface retardation of the first pour leading to an exposed aggregates surface in the joint. When concreting the subsequently fresh concrete against such rough joint required bond is ensured. Surface retardation can be achieved with **Sika® Rugasol®**.

## Vibration

Correct compaction of the concrete is a vital step within concrete production, because only with correct execution it is possible to obtain the target air void content and as a consequence the required hardened concrete properties, like compressive strength.

Internal vibration with a vibration poker should be carried out in the way that the poker is immersed quickly to the bottom of the concrete layer and then reversed in one go slowly back over the entire concrete layer. Excessive vibration can have negative impact on the homogeneity of the fresh concrete. Especially with installation of frost and freeze / thaw resistant concrete the artificially introduced micro air voids should not be destroyed.

Make sure that the poker vibrators do not come too close to the formwork skin or touch it. If they do, they exert high mechanical stress on the form surface, which can result in abrasion of the release agent and later to localized adhesion (non-release) of the concrete.

## Finishing

Depending on the casted element finishing characteristics of the concrete can play an important role.

Finishing characteristics of the fresh concrete can be influenced with the concrete mix design by fines content, utilized aggregates, w/b-ratio as well as the used admixtures in general and superplasticizer technology in particular. Especially application of suitable superplasticizers based on polycarboxylate-ether (PCE) can significantly influence the finishing characteristics of fresh concrete. In addition one can make use of finishing aids.

Timing plays a critical factor regarding finishing. Especially when finishing industrial floors with power floats it is important to evaluate the correct timing for finishing.



## 10.3 CURING

Concrete quality and durability are determined by the density of the binder matrix. Therefore durable concrete should not only be characterized by high compressive strength. Even more important is its impermeability especially in the areas near the surface. The lower the porosity and the denser the hardened cement paste near the surface, the higher the resistance to external influences, stresses and attack.



To achieve this in hardened concrete, several measures have to be undertaken to protect the fresh concrete, particularly from:

- Premature drying due to wind, sun, low humidity, etc.
- Extreme temperatures (cold, heat) and damaging rapid temperature changes
- Rain
- Thermal and physical shock
- Chemical attack
- Mechanical stress

Protection from premature drying is necessary so that the strength development of the concrete is not affected by water removal. The consequences of too early water loss are:

- Low strength in the parts near the surface
- Tendency to dusting
- Higher water permeability
- Reduced weather resistance
- Low resistance to chemical attack
- Occurrence of early age shrinkage cracks
- Increased risk of all forms of shrinkage cracking

The diagram below gives an illustration of the amount of water evaporation per  $\text{m}^2$  of concrete surface under different conditions. As can be seen from the figure (arrow marking), at air and concrete temperatures of  $20^\circ\text{C}$ , relative air humidity of 50% and an average wind speed of  $20\text{ km/h}$ ,  $0.6$  liters of water per hour can evaporate from  $1\text{ m}^2$  of concrete surface. At concrete temperatures higher than air temperature and with widening temperature differences, the rate of water evaporation increases significantly. In equal conditions, a concrete temperature of  $25^\circ\text{C}$  would result in 50% more evaporation, i.e.  $0.9$  liters per  $\text{m}^2$  per hour.

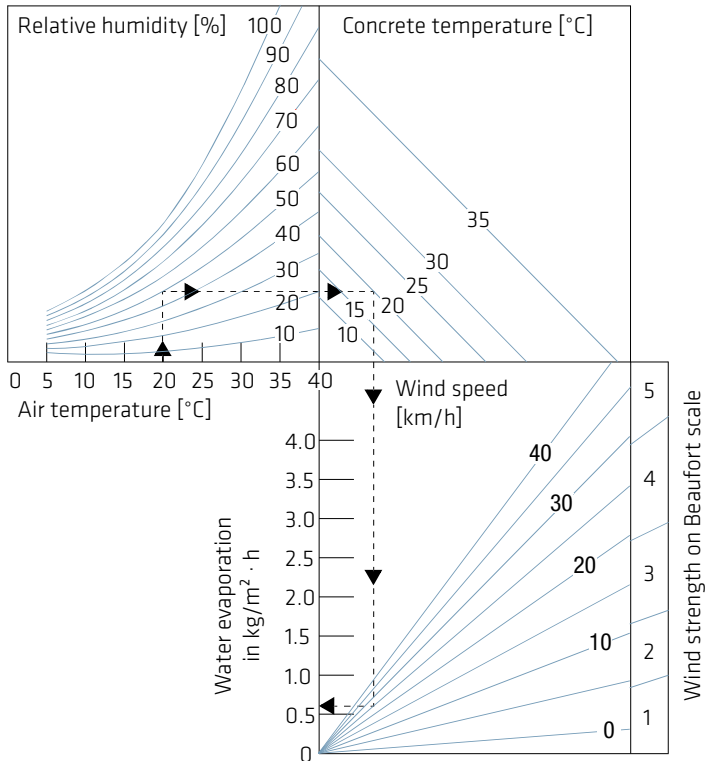

Fig. 10.3.1: Effect on evaporation of relative air humidity, air and concrete temperature as well as wind speed (according to VDZ [German Cement Manufacturers Association])

*An example to illustrate these figures:*

Fresh concrete with a water content of 180 liters per m<sup>3</sup> contains 1.8 liters of water per m<sup>2</sup> in a 1 cm thick layer. The evaporation rate of 0.6 liters per m<sup>2</sup> per hour means that the concrete loses an amount of water equivalent to the total water content of concrete layers 1 cm thick within 3 hours and 3 cm thick after 9 hours. This thickness exceeds the minimum concrete cover required for external structures according to DIN 1045.

A 'resupply' of the evaporated water from the deeper areas of the concrete only occurs to a limited extent. The negative impact on the strength, wear resistance and impermeability of the layers near the surface is considerable.

Extreme temperature effects cause the concrete to deform; it expands in heat and contracts in cold. This deformation causes stresses which can lead to cracks, as with shrinkage due to constraint. It is therefore important to prevent wide temperature differences (>15 K) between the core and the surface in fresh and new concrete and exposure to abrupt temperature changes in partially hardened concrete.

Mechanical stress such as violent oscillations and powerful shocks during setting and in the initial hardening phase can damage the concrete if its structure is loosened. Rainwater and running water often cause permanent damage to fresh or new concrete. Damage during subsequent works should be prevented by edge protection and protective covers for 'unformed' concrete surfaces and by leaving concrete longer in the formwork before striking.

Chemical attack by substances in ground water, soil or air can damage concrete or even make it unfit for its purpose, even given a suitable mix formulation and correct installation, if this stress occurs too early. These substances should be kept away from the concrete for as long as possible, e.g. by shielding, drainage or covering.

### **Curing Methods**

Protective measures against premature drying are:

- Applying liquid curing agents (e.g. **Sika® Antisol®**)
- Leaving in the forms
- Covering with sheets
- Laying water-retaining covers
- Spraying or 'misting' continuously with water, keeping it effectively submerged
- A combination of all of these methods

Liquid curing agents such as **Sika® Antisol® E-20** can be sprayed onto the concrete surface with simple tools (e.g. low pressure, garden type sprayers). They must be applied over the whole surface as early as possible: on exposed concrete faces immediately when the initial 'shiny' surface of the fresh concrete becomes 'matt', and on formed faces immediately after striking. It is always important to form a dense membrane and to apply the correct quantity (in g/m<sup>2</sup>) as specified, and in accordance with the directions for use. Several applications may be necessary on vertical concrete faces.

**Sika® Antisol® E-20** is milky white in color when fresh, making application defects or irregularities easy to detect. When it dries, it forms a transparent protective membrane.

Leaving in the form means that absorbent timber formwork must be kept moist and steel formwork must be protected from heating (i.e. by direct sunlight) and from rapid or over-cooling in low temperatures.

Careful covering with impervious plastic sheets is the most usual method for unformed surfaces and after striking of formwork components. The sheets must be laid together overlapping on the damp concrete and fixed at their joints (e.g. by weighing down with boards or stones) to prevent water evaporating from the concrete.

The use of plastic sheets is particularly recommended for fair-faced concrete, as they will largely prevent undesirable efflorescence. The sheets should not lie directly in the fresh concrete. A 'chimney effect' must also be avoided.

When enclosing concrete surfaces in water-retaining materials such as hessian, straw mats etc., the cover must be kept continuously moist or if necessary must also be given additional protection against rapid moisture loss with plastic sheets.

Premature drying can be prevented by keeping the surface continuously damp by wetting the concrete surfaces. Alternate wetting and drying can lead to stresses and therefore to cracks in the new concrete. Avoid direct spraying on the concrete surface with a water jet, as cracks can occur if the concrete surface cools due to the lower water temperature and the latent heat development of the concrete, particularly on mass concrete structures. Suitable equipment types are nozzles or perforated hoses of the type used for garden lawn sprinklers. Horizontal surfaces can be left to cure under water where possible.

Table 10.3.1: Curing measures for concrete

Method	Measures	Outside temperature in °C				
		Below -3 °C	-3 to +5 °C	5 to 10 °C	10 to 25 °C	over 25 °C
Sheet / curing membrane	Cover and/or spray with curing membrane and dampen. Wet timber formwork; protect steel formwork from sunlight					X
	Cover and/or spray with curing membrane			X	X	
	Cover and/or spray with curing membrane and heat insulation; advisable to use heat insulating formwork – e.g. timber		X*			
	Cover and heat insulation; enclose the working area (tent) or heat (e.g. radiant heater); also keep concrete temperature at +10 °C for at least 3 days	X*	X*			
Water	Keep moist by uninterrupted wetting				X	

\* Curing and striking periods are extended by the number of frosty days; protect concrete from precipitation for at least 7 days.

At low temperatures it is not enough just to prevent water loss on the concrete surface. To prevent excessive cooling, additional protective heat insulation measures must be prepared and applied in time. These depend mainly on the weather conditions, the type of components, their dimensions and the formwork.

Curing with water is not allowed in freezing temperatures. Thermal covers such as boards, dry straw and reed mats, lightweight building board and plastic mats are all suitable protection for brief periods of frost. The cover should preferably be protected on both sides from moisture with sheets. Foil-backed plastic mats are the most suitable and are easy to handle. In heavy frosts or long periods of freezing temperatures, the air surrounding the fresh concrete must be heated and the concrete surfaces must stay damp. Good sealing is important (e.g. by closing window and door openings and using enclosed working tents).

## **Curing period**

The curing period must be designed so that the areas near the surface achieve the structural strength and impermeability required for durability of the concrete, and corrosion protection of the reinforcement.

Strength development is closely connected to the concrete composition, fresh concrete temperature, ambient conditions, concrete dimensions and the curing period required is influenced by the same factors.

As part of the European standardization process, standardized European rules are being prepared for concrete curing.

The principle of the European draft is incorporated in DIN 1045-3. Its basis is that curing must continue until 50% of the characteristic strength  $f_{ck}$  is obtained in the concrete element. To define the necessary curing period, the concrete producer is required to give information on the strength development of the concrete. The information is based on the ratio of the 2 to 28 day average compressive strength at 20 °C and leads to classification in the rapid, average, slow or very slow strength development range. The minimum curing period prescribed according to DIN 1045-3 is based on these strength development ranges.



# 11 STANDARDS

## 11.1 STANDARDS EN 206

The European Concrete Standard EN 206 was introduced in Europe. In 2013, the European Standard was revised and it is now EN 206.

It applies to concrete for structures cast in situ, precast elements and structures, and structural precast products for buildings and civil engineering structures.



### It applies to

- Normal weight concrete
- Heavyweight concrete
- Lightweight concrete
- Prestressed concrete

### It does not apply to

- Aerated concrete
- Foamed concrete
- Concrete with open structure ('no-fines' concrete)
- Mortar with maximum particle diameter  $\leq 4$  mm
- Concrete with density less than  $800 \text{ kg/m}^3$
- Refractory concrete

Concrete is specified either as **designed concrete** (consideration of the exposure classification and requirements) or as **prescribed concrete** (by specifying the concrete composition).

## 11.1.1 DEFINITIONS FROM THE STANDARD

### Concrete properties, exposure

#### ■ *Designed concrete*

Concrete for which the required properties and additional characteristics are specified to the producer who is responsible for providing a concrete conforming to the required properties and additional characteristics.

#### ■ *Prescribed concrete*

Concrete for which the composition of the concrete and the constituent materials to be used are specified to the producer who is responsible for providing a concrete with the specified composition.

#### ■ *Environmental actions* (→ *exposure classes*)

Those chemical and physical actions to which the concrete is exposed and which result in effects on the concrete or reinforcement or embedded metal that are not considered as loads in structural design.

#### ■ *Specification of concrete*

Final compilation of documented technical requirements given to the producer in terms of performance or composition.

#### ■ *Standardized prescribed concrete*

Prescribed concrete for which the composition is given in a standard valid in the place of use of the concrete.

#### ■ *Specifier*

Person or body establishing the specification for the fresh and hardened concrete.

#### ■ *Producer*

Person or body producing fresh concrete.

#### ■ *User*

Person or body using fresh concrete in the execution of a construction or an element.

### Water balance of the concrete

#### ■ *Total water content*

Added water plus water already contained in the aggregates and on the surface of the aggregates plus water in the admixtures and in additions used in the form of a slurry and water resulting from any added ice or steam heating.

#### ■ *Effective water content*

Difference between the total water present in the fresh concrete and the water absorbed by the aggregates.

#### ■ *w/c-ratio*

Ratio of the effective water content to cement content by mass in the fresh concrete.

### **Load, delivery, place of use**

#### ■ *Site-mixed concrete*

Concrete produced on the construction site by the user of the concrete for his own use.

#### ■ *Ready-mixed concrete*

Concrete delivered in a fresh state by a person or body who is not the user. Ready-mixed concrete in the sense of this standard is also

- concrete produced off site by the user
- concrete produced on site, but not by the user

#### ■ *Load*

Quantity of concrete transported in a vehicle comprising one or more batches.

#### ■ *Batch*

Quantity of fresh concrete produced in one cycle of operations of a mixer or the quantity discharged during 1 min from a continuous mixer.

## **11.1.2 EXPOSURE CLASSES RELATED TO ENVIRONMENTAL ACTIONS**

The environmental actions are classified as exposure classes.

The exposure classes to be selected depend on the provisions valid in the place of use of the concrete. This exposure classification does not exclude consideration of special conditions existing in the place of use of the concrete or the application of protective measures such as the use of stainless steel or other corrosion resistant metal and the use of protective coatings for the concrete or the reinforcement.

The concrete may be subject to more than one of the actions described. The environmental conditions to which it is subjected may thus need to be expressed as a combination of exposure classes.

Table 11.1.2.1: Exposure classes according to EN 206

Class designation	Description of the environment	Informative examples where exposure classes may occur
<b>No risk of corrosion or attack</b>		
<b>X0</b>	For concrete without reinforcement or embedded metal: all exposures, except where there is freeze/thaw, abrasion or chemical attack  For concrete with reinforcement or embedded metal: very dry	Concrete inside buildings with low air humidity
<b>Corrosion induced by carbonation</b>		
<b>XC1</b>	Dry or permanently wet	Concrete inside buildings with low air humidity. Concrete permanently submerged in water
<b>XC2</b>	Wet, rarely dry	Concrete surfaces subject to longterm water contact; many foundations
<b>XC3</b>	Moderate humidity	Concrete inside buildings with moderate or high air humidity; external concrete sheltered from rain
<b>XC4</b>	Cyclic wet and dry	Concrete surfaces subject to water contact, not within exposure class XC2
<b>Corrosion induced by chlorides other than from sea water</b>		
<b>XD1</b>	Moderate humidity	Concrete surfaces exposed to airborne chlorides
<b>XD2</b>	Wet, rarely dry	Swimming pools; concrete exposed to industrial waters containing chlorides
<b>XD3</b>	Cyclic wet and dry	Parts of bridges exposed to spray containing chlorides; pavements; car park slabs
<b>Corrosion induced by chlorides from sea water</b>		
<b>XS1</b>	Exposed to airborne salt but not in direct contact with sea water	Structures near to or on the coast
<b>XS2</b>	Permanently submerged	Parts of marine structures
<b>XS3</b>	Tidal, splash and spray zones	Parts of marine structures

Table 11.1.2.2: Exposure classes according to EN 206 (Continued Table 11.1.2.1)

Class designation	Description of the environment	Informative examples where exposure classes may occur
<b>Freeze/thaw attack with or without de-icing agents</b>		
<b>XF1</b>	Moderate water saturation, without de-icing agent	Vertical concrete surfaces exposed to rain and freezing
<b>XF2</b>	Moderate water saturation, with de-icing agent	Vertical concrete surfaces of road structures exposed to freezing and airborne de-icing agents
<b>XF3</b>	High water saturation, without de-icing agent	Horizontal concrete surfaces exposed to rain and freezing
<b>XF4</b>	High water saturation, with de-icing agent	Road and bridge decks exposed to de-icing agents; concrete surfaces exposed to direct spray containing de-icing agents and freezing
<b>Chemical attack</b>		
<b>XA1</b>	Slightly aggressive chemical environment according to Table 11.1.2.3	Concrete in water treatment plants; slurry containers
<b>XA2</b>	Moderately aggressive chemical environment according to Table 11.1.2.3	Concrete components in contact with sea water; components in soil corrosive to concrete
<b>XA3</b>	Highly aggressive chemical environment according to Table 11.1.2.3	Industrial effluent plants with effluent corrosive to concrete; silage tanks; concrete structures for discharge of flue gases

Table 11.1.2.3: Test methods

Chemical characteristic		Reference test method	XA1	XA2	XA3
<b>Ground water</b>					
SO <sub>4</sub> <sup>2-</sup>	mg/L	EN 196-2	≥ 200 and ≤ 600	> 600 and ≤ 3'000	> 3'000 and ≤ 6'000
pH	mg/L	ISO 4316	≤ 6.5 and ≥ 5.5	< 5.5 and ≥ 4.5	< 4.5 and 4.0
CO <sub>2</sub> aggressive	mg/L	EN 13577	≥ 15 and ≤ 40	> 40 and ≤ 100	> 100 up to saturation
NH <sub>4</sub> <sup>+</sup>	mg/L	ISO 7150-1	≥ 15 and ≤ 30	≥ 30 and ≤ 60	> 60 and ≤ 100
Mg <sup>2+</sup>	mg/L	ISO 7980	≥ 300 and ≤ 1'000	> 1'000 and ≤ 3'000	> 3'000 up to saturation
<b>Soil</b>					
SO <sub>4</sub> <sup>2-</sup>	mg/kg <sup>a</sup> total	EN 196-2 <sup>b</sup>	≥ 2'000 and ≤ 3'000 <sup>c</sup>	≥ 3'000 <sup>c</sup> and ≤ 12'000	> 12'000 and ≤ 24'000
Acidity	mL/kg	DIN 4030-2	> 200 Baumann Gully	not encountered in practice	

<sup>a</sup> Clay soils with a permeability below 10<sup>-6</sup> m/s may be moved into a lower class.

<sup>b</sup> The test method prescribes the extraction of SO<sub>4</sub><sup>2-</sup> by hydrochloric acid; alternatively, water extraction may be used, if experience is available in the place of use of the concrete.

<sup>c</sup> The 3'000 mg/kg limit shall be reduced to 2'000 mg/kg, where there is a risk of accumulation of sulfate ions in the concrete due to drying and wetting cycles or capillary suction.

*A list of the exposure classes and associated minimum cement contents is given at the end of Extract from EN 206: Table 2: Recommended limiting values for composition and properties of concrete.*

Table 11.1.2.4: Exposure classes according to EN 206

Exposure classes		Carbonation-induced corrosion						Chloride-induced corrosion				Freeze/thaw attack				Aggressive chemical environments						
		No risk of corrosion or attack		Sea water						Chloride other than from sea water												
				XC1	XC2	XC3	XC4	XS1	XS2	XS3	XD1	XD2	XD3								XF1	XF2
Maximum w/c	-	0.65	0.60	0.55	0.50	0.50	0.50	0.45	0.45	0.45	0.55	0.55	0.45	0.55	0.55	0.50	0.45	0.55	0.50	0.45		
Minimum strength class	C12/15	C20/25	C25/30	C30/37	C30/37	C30/37	C30/37	C35/45	C35/45	C35/45	C30/37	C30/37	C30/37	C35/45	C30/37	C25/30	C30/37	C30/37	C30/37	C30/37	C35/45	
Minimum cement content [kg/m <sup>3</sup> ]	-	260	280	280	300	300	300	320	340	340	300	300	300	320	300	300	320	300	300	320	360	
Minimum air content [%]	-	-	-	-	-	-	-	-	-	-	-	-	-	-	4.0 <sup>a</sup>	4.0 <sup>a</sup>	4.0 <sup>a</sup>	4.0 <sup>a</sup>	-	-	-	
Other requirements																						Sulfate resisting cement <sup>b</sup>

a Where the concrete is not air entrained, the performance of concrete should be tested according to an appropriate test method in comparison with a concrete for which freeze/thaw resistance for the relevant exposure class is proven.

b Moderate or high sulfate resisting cement in exposure class XA2 (and in exposure class XA1 when applicable) and high sulfate resisting cement in exposure class XA3.

### 11.1.3 CLASSIFICATION BY CONSISTENCE

The classes of consistence in the tables below are not directly related. For moist concrete, i.e. concrete with low water content, the consistency is not classified.

Table 11.1.3.1: *Compaction classes*

Compaction classes	
Class	Degree of compactability
C0 <sup>a</sup>	≥ 1.46
C1	1.45 to 1.26
C2	1.25 to 1.11
C3	1.10 to 1.04
C4 <sup>b</sup>	< 1.04

<sup>b</sup> C4 applies only to light weight concrete

<sup>a</sup> For further information see Annex L, line 11 (EN206)

Table 11.1.3.2: *Flow classes*

Flow classes	
Class	Flow diameter in mm
F1 <sup>a</sup>	≤ 340
F2	350 to 410
F3	420 to 480
F4	490 to 550
F5	560 to 620
F6 <sup>a</sup>	≥ 630

<sup>a</sup> For further information see Annex L, line 11 (EN206)

Table 11.1.3.3: *Slump classes:*

Slump classes	
Class	Slump in mm
S1	10 to 40
S2	50 to 90
S3	100 to 150
S4	160 to 210
S5 <sup>a</sup>	≥ 220

<sup>a</sup> For further information see Annex L, line 11 (EN206)

Table 11.1.3.4: *Slump-flow classes*

Slump-flow classes	
Class	Slump-flow <sup>a</sup> in mm
SF1	550 to 650
SF2	660 to 750
SF3	760 to 850

<sup>a</sup> The classification is not applicable to concrete with  $D_{max}$  exceeding 40 mm



### 11.1.4 COMPRESSIVE STRENGTH CLASSES

The characteristic compressive strength of either 150 mm diameter by 300 mm cylinders or of 150 mm cubes may be used for classification.

Table 11.1.4.1: Compressive strength classes for normal weight and heavyweight concrete:

Compressive strength class	Minimum characteristic cylinder strength $f_{ck,cyl}$ N/mm <sup>2</sup>	Minimum characteristic cube strength $f_{ck,cube}$ N/mm <sup>2</sup>
C 8/10	8	10
C 12/15	12	15
C 16/20	16	20
C 20/25	20	25
C 25/30	25	30
C 30/37	30	37
C 35/45	35	45
C 40/50	40	50
C 45/55	45	55
C 50/60	50	60
C 55/67	55	67
C 60/75	60	75
C 70/85	70	85
C 80/95	80	95
C 90/105	90	105
C 100/115	100	115

Table 11.1.4.2: Compressive strength classes for lightweight concrete:

Compressive strength class	Minimum characteristic cylinder strength $f_{ck,cyl}$ N/mm <sup>2</sup>	Minimum characteristic cube strength $f_{ck,cube}$ N/mm <sup>2</sup>
LC 8/9	8	9
LC 12/13	12	13
LC 16/18	16	18
LC 20/22	20	22
LC 25/28	25	28
LC 30/33	30	33
LC 35/38	35	38
LC 40/44	40	44
LC 45/50	45	50
LC 50/55	50	55
LC 55/60	55	60
LC 60/66	60	66
LC 70/77	70	77
LC 80/88	80	88

Table 11.1.4.3: Density classes for lightweight concrete:

Density class	D 1.0	D 1.2	D 1.4	D 1.6	D 1.8	D 2.0
Range of density kg/m <sup>3</sup>	≥ 800 and ≤ 1'000	> 1'000 and ≤ 1'200	> 1'200 and ≤ 1'400	> 1'400 and ≤ 1'600	> 1'600 and ≤ 1'800	> 1'800 and ≤ 2'000

### 11.1.5 THE K-VALUE (EXTRACT FROM EN 206)

If type II additions are used (fly ash and silica fume, see Chapter 3.4, Page 36), by the k-value approach type II additions can be taken into account in the calculation of the water in the fresh concrete. The k-value concept may differ from country to country.

Use of:

Cement	“Water / cement ratio”
Cement and type II addition	“Water / (cement + $k \times$ addition) ratio”

The actual value of k depends on the specific addition.

#### ***k-value concept for fly ash conforming to EN 450***

The maximum amount of fly ash to be taken into account for the k-value concept shall meet the requirement:

CEM I: Fly ash / cement $\leq 0.33$ by mass	CEM II/A: Fly ash / cement $\leq 0.25$ by mass (EN 206)
--	--

If a greater amount of fly ash is used, the excess shall not be taken into account for the calculation of the water / (cement +  $k \times$  fly ash) ratio and the minimum cement content.

The following k-values are permitted for concrete containing cement type CEM I and CEM II/A (EN 206) conforming to EN 197-1:

CEM I and CEM II/A	$k = 0.4$
--------------------	-----------

Minimum cement content for relevant exposure class (Extract from EN 206: Annex F: Recommended limiting values for composition and properties of concrete):

This may be reduced by a maximum amount of  $k \times$  (minimum cement content - 200) kg/m<sup>3</sup>.

Additionally, the amount of (cement + fly ash) shall not be less than the minimum cement content required.

The k-value concept is not recommended for concrete containing a combination of fly ash and sulfate resisting CEM I cement in the case of exposure classes XA2 and XA3 when the aggressive substance is sulfate.

### ***k-value concept for silica fume of class 1 conforming to EN 13263-1***

The maximum amount of silica fume to be taken into account for the w/c-ratio and the cement content shall meet the requirement:

$$\text{Silica fume/cement} \leq 0,11 \text{ by mass}$$

If a greater amount of silica fume is used, the excess shall not be taken into account for the k-value concept.

k-values permitted to be applied for concrete containing cement type CEM I and CEM II/A (except cements including silica fume) conforming to EN 197-1:

w/c-ratio :

$\leq 0.45$	$k = 2.0$
$> 0.45$	$k = 2.0$ except for exposure Classes XC and XF where $k = 1.0$

Minimum cement content for relevant exposure class (see Extract from EN 206: Annex F: Recommended limiting values for composition and properties of concrete):

This shall not be reduced by more than  $30 \text{ kg/m}^3$  in concrete for use in exposure classes for which the minimum cement content is  $\leq 300 \text{ kg/m}^3$ .

Additionally, the amount of (cement +  $k \times$  Silica fume) shall be not less than the minimum cement content required for the relevant exposure class.

### ***k-value concept for ground granulated blastfurnace slag conforming to EN 15167-1 (according to prEN 206)***

The maximum amount of ground granulated blastfurnace slag (GGBS) to be taken into account for the k-value concept shall meet the requirement:

$$\text{ggbS} / \text{cement} = 1.0 \text{ by mass}$$

If a greater amount of GGBS is used, the excess shall not be taken into account for the calculation of the water / (cement +  $k \times$  ggbS) ratio and the minimum cement content.

The following k-value is applicable for concrete containing cement types CEM I and CEM II/A conforming to EN 197-1 is recommended for any GGBS conforming to EN 15167-1.

k-value	$k = 0.6$
---------	-----------

## 11.1.6 CHLORIDE CONTENT (EXTRACT FROM EN 206)

The chloride content of a concrete, expressed as the percentage of chloride ions by mass of cement, shall not exceed the value for the selected class given in the table below.

Table 11.1.6.1: Maximum chloride content of concrete

Concrete use	Chloride content class <sup>a</sup>	Maximum chloride content by mass of cement <sup>b</sup>
Not containing steel reinforcement or other embedded metal with the exception of corrosion-resisting lifting devices	Cl 1.00	1.0%
Containing steel reinforcement or other embedded metal	Cl 0.20	0.20%
	Cl 0.40 <sup>c</sup>	0.40%
Containing prestressing steel reinforcement	Cl 0.10	0.10%
	Cl 0.20	0.20%

<sup>a</sup> For a specific concrete use, the class to be applied depends upon the provisions valid in the place of use of the concrete.

<sup>b</sup> Where type II additions are used and are taken into account for the cement content, the chloride content is expressed as the percentage chloride ion by mass of cement plus total mass of additions that are taken into account.

<sup>c</sup> Different chloride classes may be permitted for concrete containing CEM III-cements according to provisions valid in the place of use.

## 11.1.7 SPECIFICATION OF CONCRETE

Table 11.1.7.1: Example: Pumped concrete for basement slab in ground water area

Specification conforming to EN 206 (designed concrete)	
Concrete conforming to EN 206 C 30/37 XC 4 Cl 0.20	D <sub>max</sub> 32 (max. particle diameter) C3 (degree of compactability) Pumpable

## 11.1.8 CONFORMITY CONTROL

This comprises the combination of actions and decisions to be taken in accordance with conformity rules adopted in advance to check the conformity of the concrete with the specification.

**The conformity control distinguishes between designed concrete and prescribed concrete. Other variable controls are also involved depending on the type of concrete.**

Table 11.1.8.1: Minimum rate of sampling for assessing compressive strength (according to EN 206)

Production	Minimum rate of sampling		
	First 50 m <sup>3</sup> of production	Subsequent to first 50 m <sup>3</sup> of production <sup>a</sup> , the highest rate given by:	
		Concrete with production control certification	Concrete without production control certification
Initial (until at least 35 test results are obtained)	3 samples	1 per 200 m <sup>3</sup> or 1 per 3 production days <sup>d</sup>	1 per 150 m <sup>3</sup> or 1 per production day <sup>d</sup>
Continuous <sup>b</sup> (when at least 35 test results are available)		1 per 400 m <sup>3</sup> or 1 per 5 production days <sup>c,d</sup> or 1 per calendar month	

<sup>a</sup> Sampling shall be distributed throughout the production and should not be more than 1 sample within each 25 m<sup>3</sup>.

<sup>b</sup> Where the standard deviation of the first 15 or more test results exceeds the upper limits for  $s_n$  according to Table 19, the sampling rate shall be increased to that required for initial production for the next 35 test results.

<sup>c</sup> Or if there are more than 5 production days within 7 consecutive calendar days, once per calendar week.

<sup>d</sup> The definition of a 'production' day shall be started in provisions valid in the place of use.

Conformity criteria for compressive strength: see EN 206.

## 11.1.9 PROOF OF OTHER CONCRETE PROPERTIES

Certificates of conformity according to EN 206 must be provided for other fresh and hardened concrete properties in addition to compressive strength.

A sampling and testing plan and conformity criteria are specified for tensile splitting strength, consistence (workability), density, cement content, air content, chloride content and w/c-ratio (see the relevant sections in EN 206).

Details of individual test methods are given in Chapter 5 and 7.

## 11.2 STANDARDS EN 934-2

The EN 934-2 specifies the definitions and requirements for admixtures for use in concrete. It covers admixtures for plain, reinforced and prestressed concrete which are used in site mixed, ready-mixed concrete and precast concrete.

The performance requirements in EN 934-2 apply to admixtures used in concrete of normal consistence. A description of the different admixture types can be found in Chapter 3.3.



The performance requirements may not be applicable to admixtures intended for other types of concrete such as semi-dry and earth moist mixes.

### 11.2.1 SPECIFIC REQUIREMENTS FROM THE STANDARD

Table 11.2.1.1: Specific requirements for water reducing / plasticizing admixtures (at equal consistence)

No.	Property	Reference concrete	Test method	Requirements
1	Water reduction	EN 480-1 reference concrete I	slump EN 12350-2 or flow EN 12350-5	In test mix $\geq 5\%$ compared with control mix
2	Compressive strength	EN 480-1 reference concrete I	EN 12390-3	At 7 and 28 days: Test mix $\geq 110\%$ of control mix
3	Air content in fresh concrete	EN 480-1 reference concrete I	EN 12350-7	Test mix $\leq 2\%$ by volume above control mix unless stated otherwise by the manufacturer

*Table 11.2.1.2: Specific requirements for high range water reducing / super plasticizing admixtures (at equal consistence)*

No.	Property	Reference concrete	Test method	Requirements
1	Water reduction	EN 480-1 reference concrete I	slump EN 12350-2 or flow EN 12350-5	In test mix $\geq 12\%$ compared with control mix
2	Compressive strength	EN 480-1 reference concrete I	EN 12390-3	At 1 day: Test mix $\geq 140\%$ of control mix At 28 days: Test mix $\geq 115\%$ of control mix
3	Air content in fresh concrete	EN 480-1 reference concrete I	EN 12350-7	Test mix $\leq 2\%$ by volume above control mix unless stated otherwise by the manufacturer

*Table 11.2.1.3: Specific requirements for high range water reducing / super plasticizing admixtures (at equal w/c-ratio)*

No.	Property	Reference concrete	Test method	Requirements
1	Increase of consistence	EN 480-1 reference concrete IV	slump EN 12350-2 or flow EN 12350-5	Increase in slump $\geq 120$ mm from initial (30 $\pm$ 10) mm Increase in flow $\geq 160$ mm from initial (350 $\pm$ 20) mm
2	Retention of consistence	EN 480-1 reference concrete IV	slump EN 12350-2 or flow EN 12350-5	30 min after addition of the consistence of the test mix shall not fall below the value of the initial consistence of the control mix
3	Compressive strength	EN 480-1 reference concrete IV	EN 12390-3	At 28 days: Test mix $\geq 90\%$ of control mix
4	Air content in fresh concrete	EN 480-1 reference concrete IV	EN 12370-7	Test mix $\leq 2\%$ by volume above control mix unless stated otherwise by the manufacturer

Note:

The superplasticizer compliance dosage used to meet the requirements of Table 11.2.1.3 does not have to be the same as that used to meet the requirements of Table 11.2.1.2.



Table 11.2.1.4: Specific requirements for water retaining admixtures (at equal consistence)

No.	Property	Reference concrete	Test method	Requirements
1	Bleeding	EN 480-1 reference concrete II	EN 480-4	In test mix $\leq$ 50% of control mix
2	Compressive strength	EN 480-1 reference concrete II	EN 12390-3	At 7 and 28 days: Test mix $\geq$ 80% of control mix
3	Air content in fresh concrete	EN 480-1 reference concrete II	EN 12350-7	Test mix $\leq$ 2% by volume above control mix unless stated otherwise by the manufacturer

Table 11.2.1.5: Specific requirements for air entraining admixtures (at equal consistence)

No.	Property	Reference concrete	Test method	Requirements <sup>a</sup>
1	Air content in fresh concrete (entrained air)	EN 480-1 reference concrete III	EN 12350-7	Test mix $\geq$ 2.5% by volume above control mix. Total air content 4% to 6% by volume
2	Air void characteristics in hardened con- crete	EN 480-1 reference concrete III	EN 480-11 <sup>b</sup>	Spacing factor in test mix $\leq$ 0.200 mm
3	Compressive strength	EN 480-1 reference concrete III	EN 12390-3	At 28 days: Test mix $\geq$ 75% of control mix

<sup>a</sup> All requirements apply to the same test mix.

<sup>b</sup> EN 480-11 is the reference method. Other methods of determining the spacing factor (e.g. modified point count method) may be used provided that they can be shown to give essentially the same results as the method in EN 480-11.

*Table 11.2.1.6: Specific requirements for set accelerating admixtures (at equal consistence)*

No.	Property	Reference concrete	Test method	Requirements
1	Initial setting time	EN 480-1 reference mortar	EN 480-2	At 20 °C: Test mix ≥ 30 min At 5 °C: Test mix ≤ 60% of control mix
2	Compressive strength	EN 480-1 reference concrete I	EN 12390-3	At 28 days: Test mix ≥ 80% of control mix At 90 days test mix ≥ test mix at 28 days
3	Air content in fresh concrete	EN 480-1 reference concrete I	EN 12350-7	Test mix ≤ 2% by volume above control mix unless stated otherwise by the manufacturer

*Table 11.2.1.7: Specific requirements for hardening accelerating admixtures (at equal consistence)*

No.	Property	Reference concrete	Test method	Requirements
1	Compressive strength	EN 480-1 reference concrete I	EN 12390-3	At 20 °C and 24h: Test mix ≥ 120% of control mix At 20 °C and 28 days: Test mix ≥ 90% of control mix At 5 °C and 48h: Test mix ≥ 130% of control mix
2	Air content in fresh concrete	EN 480-1 reference concrete I	EN 12350-7	Test mix ≤ 2% by volume above control mix unless stated otherwise by the manufacturer

Table 11.2.1.8: Specific requirements for set retarding admixtures (at equal consistence)

No.	Property	Reference concrete	Test method	Requirements
1	Setting time	EN 480-1 reference mortar	EN 480-2	Initial: Test mix ≥ control mix + 90 min Final: Test mix ≤ control mix + 360 min
2	Compressive strength	EN 480-1 reference concrete I	EN 12390-3	At 7 days: Test mix ≥ 80% of control mix At 28 days: Test mix ≥ 90% of control mi
3	Air content in fresh concrete	EN 480-1 reference concrete I	EN 12350-7	Test mix ≤ 2% by volume above control mix unless stated otherwise by the manufacturer

Table 11.2.1.9: Specific requirements for water resisting admixtures (at equal consistence or equal w/c-ratio<sup>a</sup>)

No.	Property	Reference concrete	Test method	Requirements <sup>a</sup>
1	Capillary absorption	EN 480-1 reference mortar	EN 480-5	Tested for 7 days after 7 days curing: Test mix ≤ 50% by mass of control mix Tested for 28 days after 90 days of curing: Test mix ≤ 60% by mass of control mix
2	Compressive strength	EN 480-1 reference concrete I	EN 12390-3	At 28 days: Test mix ≥ 85% of control mix
3	Air content in fresh concrete	EN 480-1 reference concrete I	EN 12350-7	Test mix ≤ 2% by volume above control mix unless stated otherwise by the manufacturer

<sup>a</sup> All tests shall be performed either at equal consistence or equal w/c-ratio

*Table 11.2.1.10: Specific requirements for set retarding /water reducing / plasticizing admixtures (at equal consistence)*

No.	Property	Reference concrete	Test method	Requirements
1	Compressive strength	EN 480-1 reference concrete I	EN 12390-3	At 28 days: Test mix $\geq 100\%$ of control mix
2	Setting time	EN 480-1 reference mortar	EN 480-2	Initial: Test mix $\geq$ control mix + 90 min Final: Test mix $\leq$ control mix + 360 min
3	Water reduction	EN 480-1 reference concrete I	slump EN 12350-2 or flow EN 12350-5	In test mix $\geq 5\%$ compared with control mix
4	Air content in fresh concrete	EN 480-1 reference concrete I	EN 12350-7	Test mix $\leq 2\%$ by volume above control mix unless stated otherwise by the manufacturer

*Table 11.2.1.11: Specific requirements for set retarding / high range water reducing / super plasticizing admixtures (at equal consistence)*

No.	Property	Reference concrete	Test method	Requirements
1	Compressive strength	EN 480-1 reference concrete I	EN 12390-3	At 7 days: Test mix $\geq 100\%$ of control mix At 28 days: Test mix $\geq 115\%$ of control mix
2	Setting time	EN 480-1 reference mortar	EN 480-2	Initial: Test mix $\geq$ control mix + 90 min Final: Test mix $\leq$ control mix + 360 min
3	Water reduction	EN 480-1 reference concrete I	slump EN 12350-2 or flow EN 12350-5	In test mix $\geq 12\%$ compared with control mix
4	Air content in fresh concrete	EN 480-1 reference concrete I	EN 12350-7	Test mix $\leq 2\%$ by volume above control mix unless stated otherwise by the manufacturer

Table 11.2.1.12: Specific requirements for set retarding / high range water reducing / super plasticizing admixtures (at equal w/c-ratio<sup>a</sup>)

No.	Property	Reference concrete	Test method	Requirements
1	Retention of consistence	EN 480-1 reference concrete IV	slump EN 12350-2 or flow EN 12350-	60 min after addition the consistence of the test mix shall not fall below the value of the initial consistence of the control mix
2	Compressive strength	EN 480-1 reference concrete IV	EN 12390-3	At 28 days: Test mix $\geq 90\%$ of control mix
3	Air content in fresh concrete	EN 480-1 reference concrete IV	EN 12350-7	Test mix $\leq 2\%$ by volume above control mix unless stated otherwise by the manufacturer

<sup>a</sup> The compliance dosage for admixtures used to meet the requirements of Table 11.2 does not have to be the same as that used to meet the requirements of Table 11.1

Table 11.2.1.13: Specific requirements for set accelerating /water reducing / plasticizing admixtures (at equal consistence)

No.	Property	Reference concrete	Test method	Requirements
1	Compressive strength	EN 480-1 reference concrete I	EN 12390-3	At 28 days: Test mix $\geq 100\%$ of control mix
2	Initial setting time	EN 480-1 reference mortar	EN 480-2	At 20 °C: Test mix $\geq 30$ min At 5 °C: Test mix $\leq 60\%$ of control mix
3	Water reduction	EN 480-1 reference concrete I	slump EN 12350-2 or flow EN 12350-5	In test mix $\geq 5\%$ compared with control mix
4	Air content in fresh concrete	EN 480-1 reference concrete I	EN 12350-7	Test mix $\leq 2\%$ by volume above control mix unless stated otherwise by the manufacturer



## 11.3 ASTM “CONCRETE AND AGGREGATES”

The ASTM standards covering the topic ‘concrete and aggregates’ are published each year in the ‘Annual Book of ASTM Standards’ Volume 04.02.

Terminology for	ASTM	Title
Concrete and Concrete Aggregates	C125	Standard Terminology Relating to Concrete and Concrete Aggregates
<b>Content</b>		

This standard is a compilation of definitions of terms as they are used in standards under the jurisdiction of Committee C09.

Other terminology under the jurisdiction of Committee C09 is included in two specialized standards. Terms relating to constituents of concrete aggregates are defined in Descriptive Nomenclature C294. Terms relating to constituents of aggregates for radiation-shielding concrete are defined in Descriptive Nomenclature C638.

Related terminology for hydraulic cement is included in Terminology C219. In the event of conflict between definitions in Terminology C125 and definitions in Terminology C219, definitions in Terminology C125 shall govern for Committee C09 standards.

When a term is used in an ASTM standard for which Committee C09 is responsible, it is included herein only if used in more than one Committee C09 standard.

Specification for	ASTM	Standard Specification for
Ready-Mixed Concrete	C94	Ready-Mixed Concrete
<b>Content</b>		

This specification covers ready-mixed concrete manufactured and delivered to a purchaser in freshly mixed and unhardened state as hereinafter specified. Requirements for quality of concrete shall be either as hereinafter specified or as specified by the purchase. In any case where the requirements of the purchaser differ from these in this specification, the purchaser’s specification shall govern. In the absence of designated applicable materials specifications, materials specifications specified shall be used for cementitious materials, hydraulic cement, supplementary cementitious materials, cementitious concrete mixtures, aggregates, air-entraining admixtures, and chemical admixtures. Except as otherwise specifically permitted, cement, aggregate, and admixtures shall be measured by mass. Mixers will be stationary mixers or truck mixers. Agitators will be truck mixers or truck agitators. Test methods for compression, air content, slump, temperature shall be performed. For strength test, at least two standard test specimens shall be made.

Specification for	ASTM	Standard Specification for
Fiber-Reinforced Concrete	C1116	Fiber-Reinforced Concrete

**Content**

This specification covers all forms of fiber-reinforced concrete that are delivered to a purchaser with the ingredients uniformly mixed, and that can be sampled and tested at the point of delivery. It does not cover the placement, consolidation, curing, or protection of the fiber-reinforced concrete after delivery to the purchaser.

Specification for	ASTM	Standard Specification for
Lightweight Aggregates and Concrete	C330	Lightweight Aggregates for Structural Concrete

**Content**

This specification covers lightweight aggregates intended for use in structural concrete in which prime considerations are reducing the density while maintaining the compressive strength of the concrete. Procedures covered in this specification are not intended for job control of concrete. Two general types of lightweight aggregates are covered by this specification: aggregates prepared by expanding, pelletizing, or sintering products such as blast-furnace slag, clay, diatomite, fly ash, shale, or slate; and aggregates prepared by processing natural materials, such as pumice, scoria, or tuff. The aggregates shall be composed predominately of lightweight-cellular and granular inorganic material. Lightweight aggregates shall be tested, and should not contain excessive amounts of deleterious substances; and should conform to the specified values of organic impurities, aggregate staining, aggregate loss of ignition, clay lumps and friable particles, loose bulk density, compressive strength, drying shrinkage, popouts, and resistance to freezing and thawing.

Specification for	ASTM	Standard Specification for
Polymer-Modified Concrete and Mortars	C1438	Latex and Powder Polymer Modifiers for Hydraulic Cement Concrete and Mortar

**Content**

This specification covers the performance criteria for latex and powder polymer modifiers for improving the adhesion and reducing permeability of hydraulic cement concrete and mortar. The polymer modifiers are classified either for general use or for use in areas not exposed to moisture and should be able to produce test mortar or test concrete that conforms to the specified requirements.



Specification for	ASTM	Standard Specification for
Ready-Mixed Concrete	C685	Concrete Made by Volumetric Batching and Continuous Mixing

#### Content

This specification covers concrete made by volumetric batching and continuous mixing. Requirements for quality of concrete shall be either as hereinafter specified or as specified by the purchaser. When the requirements of the purchaser differ from this specification, the purchaser's specification shall govern. This specification does not cover the placement, consolidation, finishing, curing, or protection of the concrete after delivery to the purchaser. Tests and criteria for batching accuracy and mixing efficiency are specified herein. Materials such as cement, aggregates, water, ground granulated blast-furnace slag, air-entraining admixtures, and chemical admixtures shall conform to the requirements covered in this specification. The material shall be subjected to the following test methods: compression test specimens; compression tests; yield; unit weight; air content; slump; and temperature.

Specification for	ASTM	Standard Specification for
Ready-Mixed Concrete	C1602	Mixing Water Used in the Production of Hydraulic Cement Concrete

#### Content

This specification covers mixing water used in the production of hydraulic cement concrete. It defines sources of water and provides requirements and testing frequencies for qualifying individual or combined water sources. Mixing water shall consist of: batch water, ice, water added by truck operator, free moisture on the aggregates, and water introduced in the form of admixtures. Potable and non-potable water is permitted to be used as mixing water in concrete. The following are concrete performance requirements for mixing water: compressive strength and time of set. Density of water shall be tested or monitored with a hydrometer. Optional chemical limits for combined mixing water are given for: chloride, sulfate, alkalis, and total solids.

Specification for	ASTM	Standard Specification for
Supplementary Cementitious Materials	C1697	Blended Supplementary Cementitious Materials

#### Content

This specification covers blended supplementary cementitious materials that result from the blending or intergrinding of two or three ASTM compliant supplementary cementitious materials, for use in concrete or mortar where hydraulic or pozzolanic action, or both, is desired. The supplementary cementitious materials include slag cement conforming to Specification C989, natural pozzolans and coal fly ash conforming to Specification C618 and silica fume conforming to Specification C1240

Specification for	ASTM	Standard Specification for
Supplementary Cementitious Materials	C618	Coal Fly Ash and Raw or Calcined Natural Pozzolan for Use in Concrete

#### Content

This specification covers coal fly ash and raw or calcined natural pozzolan for use in concrete where cementitious or pozzolanic action, or both, is desired, or where other properties normally attributed to fly ash or pozzolans may be desired, or where both objectives are to be achieved. Fly ash and natural pozzolans shall conform to the prescribed chemical composition requirements and physical requirements. The materials shall be tested for fineness, strength activity index, water requirement, soundness, and autoclave expansion or contraction.

Specification for	ASTM	Standard Specification for
Supplementary Cementitious Materials	C1240	Silica Fume Used in Cementitious Mixtures

#### Content

This specification covers silica fume for use in concrete and other systems containing hydraulic cement. The material shall be composed of silica fume, mostly of amorphous silica. Test methods for chemical analysis, moisture content and loss on ignition, bulk density, specific surface, air entrainment of mortar, strength activity index, reactivity with cement alkalis, and sulfate resistance of silica fume shall conform to this specification. Physical tests shall include determining the specimen's density and the specific surface by utilizing the BET, nitrogen adsorption method. Silica fume shall be stored in such a manner as to permit easy access for the proper inspection and identification of each shipment.

## 11.4 ASTM FOR ADMIXTURES

The ASTM C494 'Standard Specification for Chemical Admixtures for Concrete' covers materials for use as chemical admixtures to be added to hydraulic-cement concrete mixtures in the field for the purpose or purposes indicated for the eight types as follows:

- **Type A:** Water-reducing admixtures  
an admixture that reduces the quantity of mixing water required to produce concrete of a given consistency
- **Type B:** Retarding admixtures  
an admixture that retards the setting of concrete
- **Type C:** Accelerating admixtures  
an admixture that accelerates the setting and early strength development of concrete
- **Type D:** Water-reducing and retarding admixtures  
an admixture that reduces the quantity of mixing water required to produce concrete of a given consistency and retards the setting of concrete
- **Type E:** Water-reducing and accelerating admixtures  
an admixture that reduces the quantity of mixing water required to produce concrete of a given consistency and accelerates the setting and early strength development of concrete
- **Type F:** Water-reducing, high range admixtures  
an admixture that reduces the quantity of mixing water required to produce concrete of a given consistency by 12% or greater
- **Type G:** Water-reducing, high range, and retarding admixtures  
an admixture that reduces the quantity of mixing water required to produce concrete of a given consistency by 12% or greater and retards the setting of concrete
- **Type S:** Specific performance admixtures  
an admixture that provides a desired performance characteristic(s) other than reducing water content, or changing the time of setting of concrete, or both, without any adverse effects on fresh, hardened and durability properties of concrete as specified herein, excluding admixtures that are used primarily in the manufacture of dry-cast concrete products

Table 11.4.1: Physical requirements of a concrete containing admixture to pass for the specific admixture type

Physical Requirements for Concrete Containing Admixtures <sup>A</sup>								
	Type A	Type B	Type C	Type D	Type E	Type F	Type G	Type S
	Water Reducing	Retarding	Accelerating	Water Reducing and Retarding	Water Reducing and Accelerating	Water Reducing, High Range	Water Reducing, High Range and Retarding	Specific Performance
Water content max. % of control	95			95	95	88	88	
Time of setting allowable deviation from control, h: min								
Initial: at least		1:00 later	1:00 earlier	1:00 later	1:00 earlier		1:00 later	
not more than	1:00 earlier nor 1:30 later	3:30 later	3:30 earlier	3:30 later	3:30 earlier	1:00 earlier nor 1:30 later	3:30 later	1:00 earlier nor 1:30 later
Final: at least			1:00 earlier		1:00 earlier			
not more than	1:00 earlier nor 1:30 later	3:30 later		3:30 later		1:00 earlier nor 1:30 later	3:30 later	1:00 earlier nor 1:30 later
Compressive strength, min. % of control <sup>B</sup>								
1 day						140	125	
3 days	110	90	125	110	125	125	125	90
7 days	110	90	100	110	110	115	115	90
28 days	110	90	100	110	110	110	110	90
	(120) <sup>C</sup>			(120) <sup>C</sup>		(120) <sup>C</sup>	(120) <sup>C</sup>	
90 days	(117) <sup>C</sup>	n/a	n/a	(117) <sup>C</sup>	n/a	(117) <sup>C</sup>	(117) <sup>C</sup>	n/a
6 month	100	90	90	100	100	100	100	90
	(113) <sup>C</sup>			(113) <sup>C</sup>		(113) <sup>C</sup>	(113) <sup>C</sup>	
1 year	100	90	90	100	100	100	100	90
Flexural strength, min. % of control <sup>B</sup>								
3 days	100	90	110	100	110	110	110	90
7 days	100	90	100	100	100	100	100	90
26 days	100	90	90	100	100	100	100	90
Length change, max. shrinkage (alternative requirements): <sup>D</sup>								
Percent of control	135	135	135	135	135	135	135	135
Increase over control	0.01	0.01	0.01	0.01	0.01	0.01	0.01	0.01
Relative durability factor, min <sup>E</sup>	80	80	80	80	80	80	80	80

<sup>A</sup> The values in the table included allowance for normal variation in test results. The object of the 90% compressive strength requirements for Type B and Type S admixture is to require a level of performance comparable to that of the reference concrete.

<sup>B</sup> The compressive and flexural strength of the concrete containing admixture under test at any test gage shall not be less than 90% of that attained at an previous test age. The objective of this limit is to require that the compressive or flexural strength of the concrete containing the admixture under test shall not decrease with age.

<sup>C</sup> Alternative requirement. If the physical requirements are met and any of the measured relative strengths are greater than the requirement in parentheses, the admixture shall be considered provisionally qualified until the 1-year strength test results obtained.

<sup>D</sup> Alternative requirement (see ASTM C494, 17.1.4) % of control limit applies when length change of control is 0.030% or greater, increase over control limit applies when length change of control is less than 0.030%.

<sup>E</sup> This requirement is applicable only when the admixture is to be used in air entrained concrete which may be exposed to freezing and thawing while wet.

Specification for	ASTM	Standard Specification for
Chemical Admixtures	C260	Air-Entraining Admixtures for Concrete

#### Content

This specification covers the materials proposed for use as air-entraining admixtures to be added to concrete mixtures in the field. The air-entraining admixture shall conform to the requirements such as initial and final time of setting, compressive strength, flexural strength, and length change (maximum shrinkage)..

Specification for	ASTM	Standard Specification for
Chemical Admixtures	C1582	Admixtures to Inhibit Chloride-Induced Corrosion of Reinforcing Steel in Concrete

#### Content

This specification covers material for use as chloride-corrosion-inhibiting admixtures for concrete. Concrete must meet the physical requirements such as compressive strength and flexural strength. The test admixture must show corrosion-inhibiting performance with the required mean integrated macrocell current of test beams and mean corroded area of test beams as a fraction of control. At the completion of testing, the mean chloride-ion content of the test beams must be greater than or equal to the critical chloride-ion content.

Two types of concrete are used to make test specimens. One, the control concrete, is made without the chloride-corrosion-inhibiting admixture. The other concrete, the test concrete, is made with the chloride-corrosion-inhibiting admixture. Tests of freshly mixed concrete include slump test, air content test, and time of setting test. Test of hardened concrete include compressive strength test, flexural strength test, resistance to freezing and thawing test, and length change test. Corrosion testing shall also be done.

Specification for	ASTM	Standard Specification for
Shotcrete	C1141	Admixtures for Shotcrete

#### Content

This specification covers materials proposed for use as admixtures to be added to a Portland-cement shotcrete mixture for the purpose of altering the properties of the mixture. The material shall be classified as Type I (dry-mix shotcrete, with Grades 1-9) and Type II (wet-mix shotcrete, with Grades 1-9). Each of the grades shall be further classified by identifying it accordingly as Class A (liquid) or Class B (non-liquid). Shotcrete admixtures shall conform to the requirements for the applicable type and grade. Samples shall be either grab or composite samples, as specified or required by this specification. The number of tests and retests to be performed on the specified materials shall be the number stipulated in the referenced standard.



# 12 INDEX

3D Concrete printing	126	Chloride content	50, 256
<hr/>		Chloride migration	164
<b>A</b>		Cohesion	46, 87
AAR resistance	160	Cold weather concrete	67, 81, 86
Abrasion resistance	46, 58, 104, 154, 190, 199	Colored concrete	39, 123, 126, 208
Abrasion resistant concrete	190	Compactability	68, 70, 251
Absolute volume method	54	Compaction classes	251
Accelerator	16, 37, 38, 43, 110, 113, 115, 137, 180, 187	Compressive strength	56, 135, 138, 252
Additions	44, 160, 166, 188, 245, 254	Compressive strength classes	135, 252
Admixtures	8, 9, 14, 16, 18, 20, 36, 54, 67, 91, 98, 105, 112, 121, 210, 222, 258, 270	Concrete	8, 10, 24
Aggregate	8, 16, 24, 28, 32, 52, 55, 67, 81, 88, 266	Concrete admixture	8, 14, 36
Air-entrainer	9, 43, 174	Concrete aggregate	28, 266
Air void content	90, 176, 218, 236	Concrete for traffic areas	100
Air voids	38, 112, 127, 132, 174, 213, 237	Concrete installation	92, 236
Alkali-free accelerator	112	Concrete mix design	52
Alkali-Silica-Reaction	43, 160, 186	Concrete printing	126
Alkali-Silica-resistant concrete	186	Concrete surface	88, 228, 239
ASR	38, 160, 186	Concrete temperature	76, 81, 86, 239
ASTM 'Concrete and Aggregates'	266	Conformity control	257
ASTM for Admixtures	270	Consistence	11, 67, 251
<hr/>		Consistence classification	251
<b>B</b>		Corrosion	164, 170
Binder	24, 52	Corrosion resistant concrete	170
Binder content	57, 98	Crushed aggregates	92
Bleeding	35, 87, 88, 260	Cubes	130
Break pattern	138, 139	Curing	12, 132, 238
<hr/>		Curing agent	43, 240
<b>C</b>		Curing methods	240
Capillary porosity	55, 148, 166	Curing period	242
Capillary void	122, 150	Cylinders	130
Cement	8, 10, 24, 27, 81, 254	<hr/>	
Cement type	26, 27	<b>D</b>	
Cements components	25	Degree of compactability	68, 70, 251
Chemical resistance	156, 194	Dense-flow process	112
Chemical resistant concrete	194	Density of fresh concrete	54, 85
Chemical shrinkage	146, 200	Density of hardened concrete	134
		Dosage of admixtures	36

Drinking water	50
Drying	64, 229, 238
Drying shrinkage	38, 146, 200
Dry shakes	104

## E

EN 206	36, 244
EN 934-2	36, 258
E-Modulus	46, 144, 204
Environment	14, 20, 247
Ettringite	158, 178
Evaporation	79, 146, 200, 219, 232, 239
Exposed aggregates	236
Exposure classes	246

## F

Fair-faced concrete	206, 230
Fiber reinforced concrete	46, 65, 191, 202, 267
Fiber types	204
Fibers	46
Fines content	32, 52, 92, 97
Finishing	11, 237
Fire resistance	48, 162, 182, 203
Fire resistant concrete	182
Flexural strength	141, 204
Flow classes	251
Flow table spread	68, 71, 251
Flow table test	71
Flowability	67
Fly ash	25, 44, 254, 268
Formwork, absorbent	230
Formwork, non-absorbent	231
Formwork pressure	99
Fresh concrete	8, 52, 64, 238, 245
Freeze resistance strength	81
Frost and freeze / thaw resistance	94, 152
Frost and freeze / thaw resistant concrete	174, 237
Frost resistance	16, 152, 176

## G

Granulometric composition	29
Ground granulated blast-furnace slag	44, 161, 164
Ground water	14, 50, 219, 249

## H

Hardened concrete	8, 24, 130
Hardening accelerator	38

Heat backflow process	118
Heat loss	82
Heavyweight aggregates	30, 215
Heavyweight concrete	8, 214, 244
High early strength concrete	137
Hot weather concrete	67, 76, 86
Hydration	9, 24, 36, 76
Hydration heat	103, 214

## I

Impermeability	137, 148, 166
Inactive material	44
Industrial floors	104, 156, 196, 237
Inert material	44
Inherent compactability	96
Initial setting	39, 76, 79, 200, 261

## J

Joints	102, 146, 166, 222, 225
--------	-------------------------

## K

k-value	64, 254
---------	---------

## L

L-box	73
Lightweight aggregates	28, 30, 84, 184, 213, 267
Lightweight concrete	8, 28, 212, 244, 253
Lime filler	44
Lubricant mix	94

## M

Mass concrete	102, 241
Microwave testing method	65
Mix design	52, 60
Minimum binder content	198
Minimum cement content	250, 254
Minimum temperature	82
Mixing time	66, 176, 202
Mixing water	36, 51, 81, 268
Mix stabilizer	210
Molds	130
Mold release agent	43, 228, 230, 236
Monolithic concrete	104

## N

Night retardation	78
-------------------	----



---

**P**

Pan testing method	65
Particle size distribution curves	30, 53
Particle size group	29
Passing sieve	53, 93
Paste volume	56
Pavers	120
Paving tiles	120
Paving stones	120
Pervious concrete	218
Plastic shrinkage	146, 167, 200, 203
Polypropylene fibers	48, 185, 204
Portland cement	24
Pozzolan	24
Precast, wet	114
Precast, semi-dry	120
Prisms	130
Protective coating	119, 171, 246
Pumped concrete	92

---

**R**

Ready-mixed concrete	90, 246, 258, 266
Rebound	110, 140
Rebound hammer	83, 140
Recompaction	147
Retardation	38, 67, 76
Retarder	37, 38, 43, 76
Roller-compacted concrete	106

---

**S**

Sampling	257
Sand	28, 32
SCC	96
SCM	44
Segregation	35, 67, 75, 87
Self-compacting concrete	96
Semi-dry concrete	120
Separation	87
Set accelerator	38
Shrinkage	16, 43, 46, 146, 200, 203
Shrinkage controlled concrete	200
Sieve segregation test	75
Sieve size	29
Silica dust	25, 44
Skin cracks	102
Slag	24, 44, 137, 255
Slag cement	27, 45

Slipform concrete	108
Slump classes	251
Slump test	69
Slump-flow test	72
Slump-flow classes	251
Smoothing	67
Spacing factor SF	176, 260
Spalling	46, 156, 158, 160, 162
Specimens	130
Sprayed concrete	110
Spun pile concrete	218
Stabilizer	33, 38, 43
Steam curing	114
Steel fibers	47, 202
Strength development	135, 137
Sulfate	158, 178
Sulfate resistant concrete	178
Sustainability	14
Superplasticizer	14, 37
Supplementary cementitious materials	44
Surface retarder	43, 101

---

**T**

t500	72
Temperature	67, 76, 81, 86
Tensile strength	46, 143, 202
Testing machine	133
Traffic area	100
Tunnel segment concrete	118

---

**U**

Underwater concrete	210
---------------------	-----

---

**V**

V-funnel test	74
---------------	----

---

**W**

w/c-ratio	64
Water conductivity	149, 168
Water content	55, 64
Water penetration depth	148, 168
Waterproof concrete	166, 222
Water reducing admixture	37
Water resisting admixture	38, 43, 167, 262
Watertightness	148
Watertight concrete systems	222
Wet precast concrete	114

White box	222
White box concept	222
White knuckle syndrome	96
Wood sugar	80, 230
Workability	67

---

## **Y**

Young's modulus of elasticity	144
-------------------------------	-----



# FOR MORE CONCRETE INFORMATION



## WE ARE SIKA

Sika is a specialty chemicals company with a leading position in the development and production of systems and products for bonding, sealing, damping, reinforcing and protecting in the building sector and the motor vehicle industry. Sika's product lines feature concrete admixtures, mortars, sealants and adhesives, structural strengthening systems, flooring as well as roofing and waterproofing systems.

Our most current General Sales Conditions shall apply.  
Please consult the most current local Product Data Sheet prior to any use.



**SIKA SERVICES AG**  
Tueffenwies 16  
CH-8048 Zurich  
Switzerland

**Contact**  
Phone +41 58 436 40 40  
[www.sika.com](http://www.sika.com)

**BUILDING TRUST**

